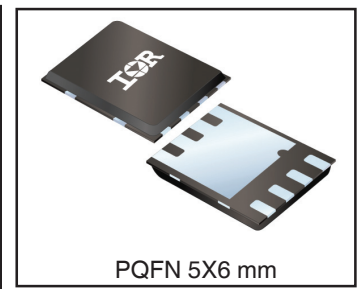
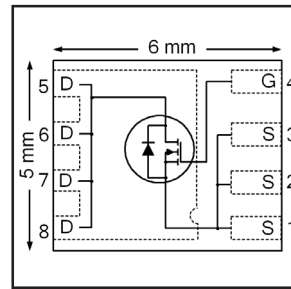


# IRFH5300PbF

HEXFET® Power MOSFET

$V_{DS}$	<b>30</b>	<b>V</b>
$R_{DS(on) \text{ max}}$ (@ $V_{GS} = 10V$ )	<b>1.4</b>	<b>m<math>\Omega</math></b>
$Q_g$ (typical)	<b>50</b>	<b>nC</b>
$R_G$ (typical)	<b>1.3</b>	<b><math>\Omega</math></b>
$I_D$ (@ $T_{C(Bottom)} = 25^\circ C$ )	<b>100</b> Ⓔ	<b>A</b>



## Applications

- OR-ing MOSFET for 12V (typical) Bus in-Rush Current
- Battery Operated DC Motor Inverter MOSFET

## Features and Benefits

### Features

Low $R_{DSon}$ ( $\leq 1.4m\Omega$ )
Low Thermal Resistance to PCB ( $\leq 0.5^\circ C/W$ )
100% Rg tested
Low Profile ( $\leq 0.9$ mm)
Industry-Standard Pinout
Compatible with Existing Surface Mount Techniques
RoHS Compliant Containing no Lead, no Bromide and no Halogen
MSL1, Industrial Qualification

results in  
⇒

### Benefits

Lower Conduction Losses
Enable better thermal dissipation
Increased Reliability
Increased Power Density
Multi-Vendor Compatibility
Easier Manufacturing
Environmentally Friendlier
Increased Reliability

Orderable part number	Package Type	Standard Pack		Note
		Form	Quantity	
IRFH5300TRPBF	PQFN 5mm x 6mm	Tape and Reel	4000	
IRFH5300TR2PBF	PQFN 5mm x 6mm	Tape and Reel	400	

## Absolute Maximum Ratings

	Parameter	Max.	Units
$V_{DS}$	Drain-to-Source Voltage	30	V
$V_{GS}$	Gate-to-Source Voltage	$\pm 20$	
$I_D @ T_A = 25^\circ C$	Continuous Drain Current, $V_{GS} @ 10V$	40	A
$I_D @ T_A = 70^\circ C$	Continuous Drain Current, $V_{GS} @ 10V$	32	
$I_D @ T_{C(Bottom)} = 25^\circ C$	Continuous Drain Current, $V_{GS} @ 10V$	100 Ⓔ	
$I_D @ T_{C(Bottom)} = 100^\circ C$	Continuous Drain Current, $V_{GS} @ 10V$	100 Ⓔ	
$I_{DM}$	Pulsed Drain Current ①	400	
$P_D @ T_A = 25^\circ C$	Power Dissipation ⑤	3.6	W
$P_D @ T_{C(Bottom)} = 25^\circ C$	Power Dissipation ⑤	250	
	Linear Derating Factor ⑤	0.029	W/°C
$T_J$ $T_{STG}$	Operating Junction and Storage Temperature Range	-55 to + 150	°C

Notes ① through ⑥ are on page 8

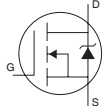
## Static @ T<sub>J</sub> = 25°C (unless otherwise specified)

	Parameter	Min.	Typ.	Max.	Units	Conditions
B <sub>V</sub> DSS	Drain-to-Source Breakdown Voltage	30	—	—	V	V <sub>GS</sub> = 0V, I <sub>D</sub> = 250μA
ΔB <sub>V</sub> DSS/ΔT <sub>J</sub>	Breakdown Voltage Temp. Coefficient	—	0.02	—	V/°C	Reference to 25°C, I <sub>D</sub> = 1mA
R <sub>DS(on)</sub>	Static Drain-to-Source On-Resistance	—	1.1	1.4	mΩ	V <sub>GS</sub> = 10V, I <sub>D</sub> = 50A ③
		—	1.7	2.1		V <sub>GS</sub> = 4.5V, I <sub>D</sub> = 50A ③
V <sub>GS(th)</sub>	Gate Threshold Voltage	1.35	1.8	2.35	V	V <sub>DS</sub> = V <sub>GS</sub> , I <sub>D</sub> = 150μA
ΔV <sub>GS(th)</sub>	Gate Threshold Voltage Coefficient	—	-6.2	—	mV/°C	
I <sub>DSS</sub>	Drain-to-Source Leakage Current	—	—	5.0	μA	V <sub>DS</sub> = 24V, V <sub>GS</sub> = 0V
		—	—	150		V <sub>DS</sub> = 24V, V <sub>GS</sub> = 0V, T <sub>J</sub> = 125°C
I <sub>GSS</sub>	Gate-to-Source Forward Leakage	—	—	100	nA	V <sub>GS</sub> = 20V
	Gate-to-Source Reverse Leakage	—	—	-100		V <sub>GS</sub> = -20V
g <sub>fs</sub>	Forward Transconductance	190	—	—	S	V <sub>DS</sub> = 15V, I <sub>D</sub> = 50A
Q <sub>g</sub>	Total Gate Charge	—	120	—	nC	V <sub>GS</sub> = 10V, V <sub>DS</sub> = 15V, I <sub>D</sub> = 50A
Q <sub>gs1</sub>	Pre-V <sub>th</sub> Gate-to-Source Charge	—	12	—	nC	V <sub>DS</sub> = 15V V <sub>GS</sub> = 4.5V I <sub>D</sub> = 50A See Fig.17 & 18
Q <sub>gs2</sub>	Post-V <sub>th</sub> Gate-to-Source Charge	—	6.5	—		
Q <sub>gd</sub>	Gate-to-Drain Charge	—	16	—		
Q <sub>godr</sub>	Gate Charge Overdrive	—	16	—		
Q <sub>sw</sub>	Switch Charge (Q <sub>gs2</sub> + Q <sub>gd</sub> )	—	23	—		
Q <sub>oss</sub>	Output Charge	—	30	—	nC	V <sub>DS</sub> = 16V, V <sub>GS</sub> = 0V
R <sub>G</sub>	Gate Resistance	—	1.3	—	Ω	
t <sub>d(on)</sub>	Turn-On Delay Time	—	26	—	ns	V <sub>DD</sub> = 15V, V <sub>GS</sub> = 4.5V I <sub>D</sub> = 50A R <sub>G</sub> = 1.8Ω See Fig.15
t <sub>r</sub>	Rise Time	—	30	—		
t <sub>d(off)</sub>	Turn-Off Delay Time	—	31	—		
t <sub>f</sub>	Fall Time	—	13	—		
C <sub>iss</sub>	Input Capacitance	—	7200	—	pF	V <sub>GS</sub> = 0V V <sub>DS</sub> = 15V f = 1.0MHz
C <sub>oss</sub>	Output Capacitance	—	1360	—		
C <sub>rfs</sub>	Reverse Transfer Capacitance	—	590	—		

## Avalanche Characteristics

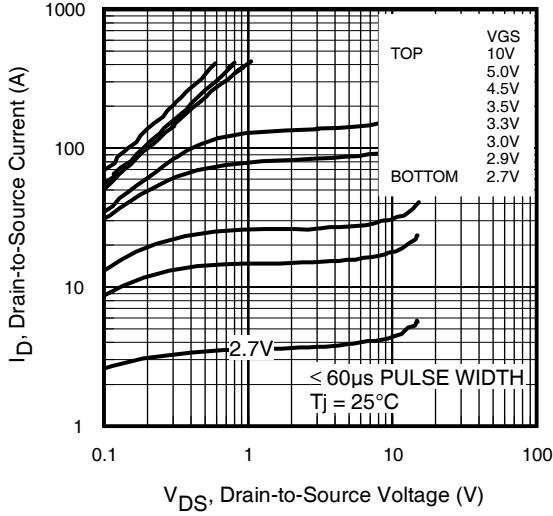
	Parameter	Typ.	Max.	Units
E <sub>AS</sub>	Single Pulse Avalanche Energy ②	—	420	mJ
I <sub>AR</sub>	Avalanche Current ①	—	50	A

## Diode Characteristics

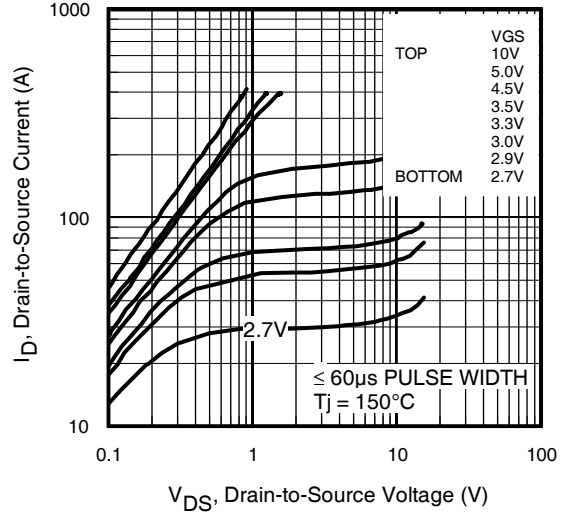
	Parameter	Min.	Typ.	Max.	Units	Conditions
I <sub>S</sub>	Continuous Source Current (Body Diode)	—	—	100 ⑥	A	MOSFET symbol showing the integral reverse p-n junction diode. 
I <sub>SM</sub>	Pulsed Source Current (Body Diode) ①	—	—	400		
V <sub>SD</sub>	Diode Forward Voltage	—	—	1.0	V	T <sub>J</sub> = 25°C, I <sub>S</sub> = 50A, V <sub>GS</sub> = 0V ③
t <sub>rr</sub>	Reverse Recovery Time	—	34	51	ns	T <sub>J</sub> = 25°C, I <sub>F</sub> = 50A, V <sub>DD</sub> = 15V
Q <sub>rr</sub>	Reverse Recovery Charge	—	68	100	nC	di/dt = 200A/μs ③
t <sub>on</sub>	Forward Turn-On Time	Time is dominated by parasitic Inductance				

## Thermal Resistance

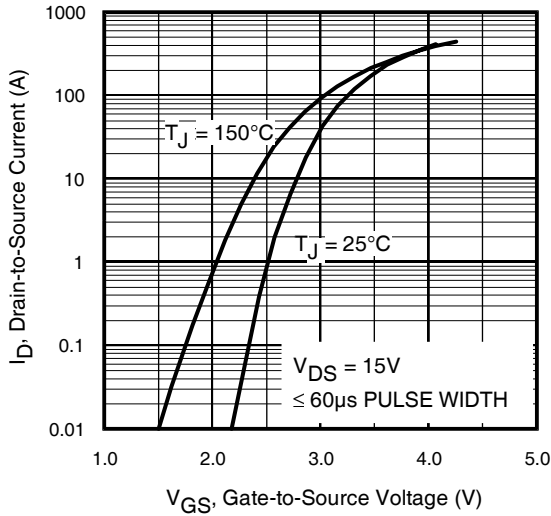
	Parameter	Typ.	Max.	Units
R <sub>θJC</sub> (Bottom)	Junction-to-Case ④	—	0.5	°C/W
R <sub>θJC</sub> (Top)	Junction-to-Case ④	—	15	
R <sub>θJA</sub>	Junction-to-Ambient ⑤	—	35	
R <sub>θJA</sub> (<10s)	Junction-to-Ambient ⑤	—	21	



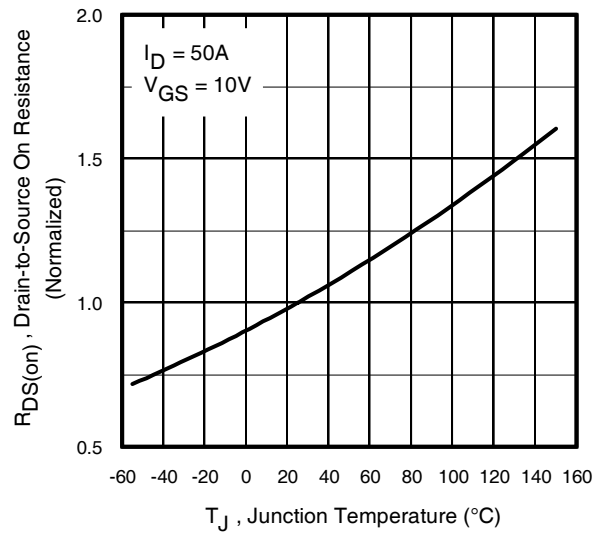
**Fig 1.** Typical Output Characteristics



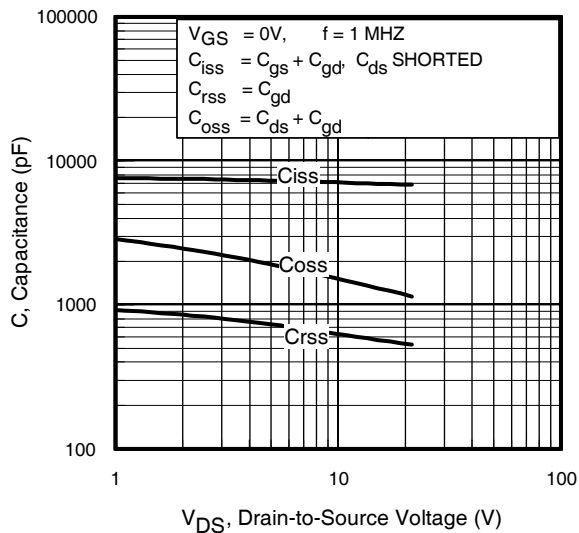
**Fig 2.** Typical Output Characteristics



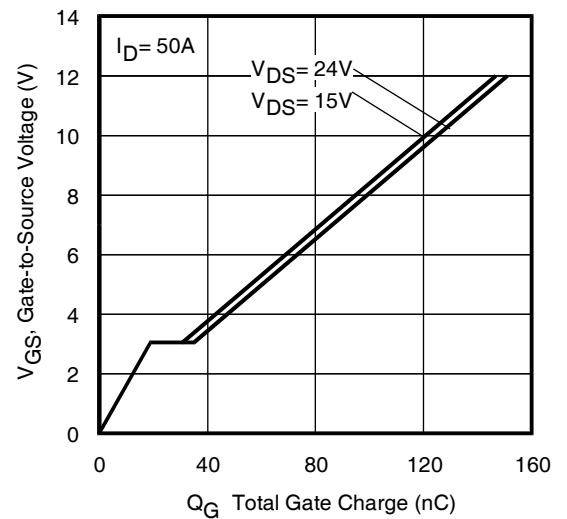
**Fig 3.** Typical Transfer Characteristics



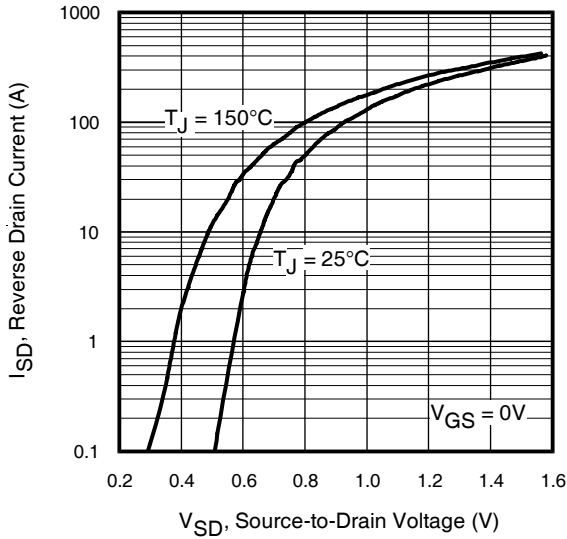
**Fig 4.** Normalized On-Resistance Vs. Temperature



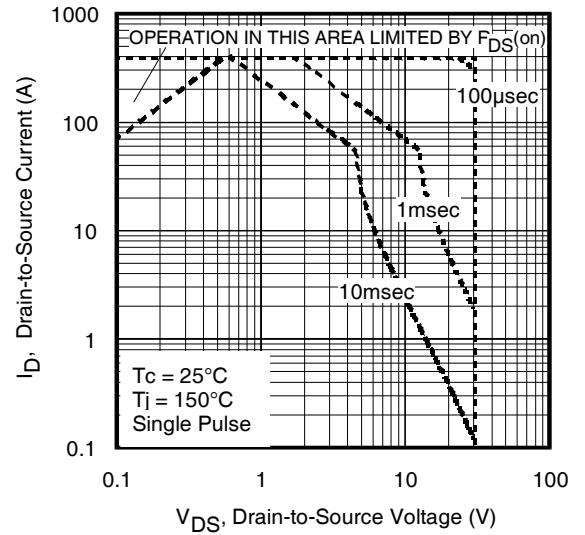
**Fig 5.** Typical Capacitance Vs. Drain-to-Source Voltage  
www.irf.com



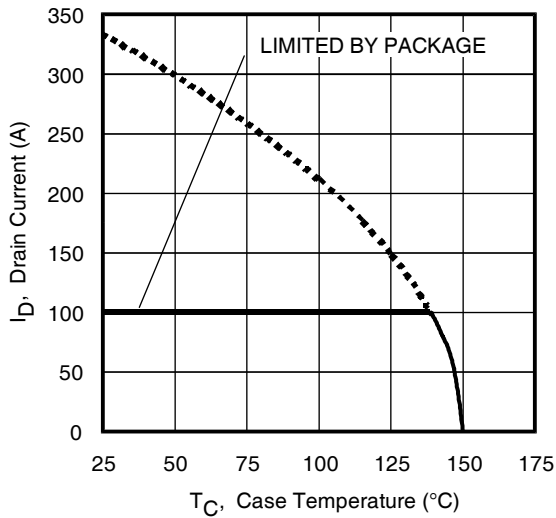
**Fig 6.** Typical Gate Charge Vs. Gate-to-Source Voltage  
3



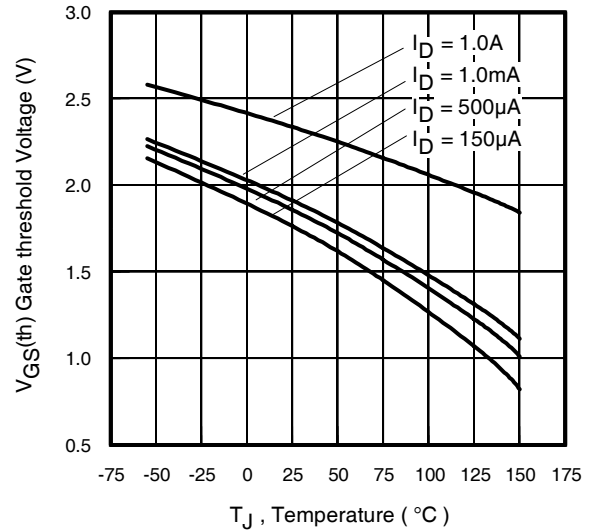
**Fig 7.** Typical Source-Drain Diode Forward Voltage



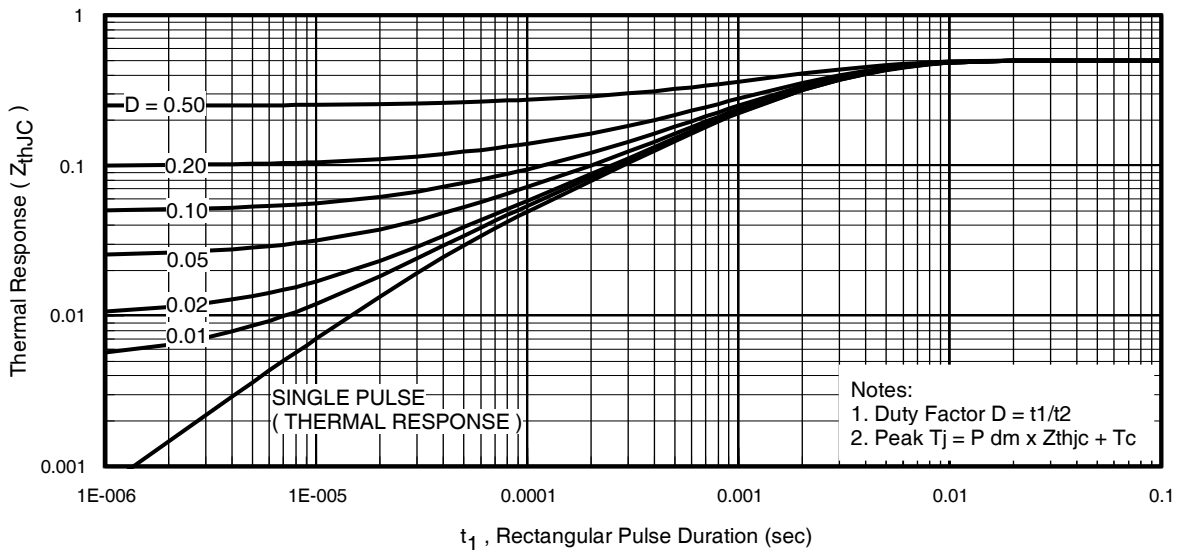
**Fig 8.** Maximum Safe Operating Area



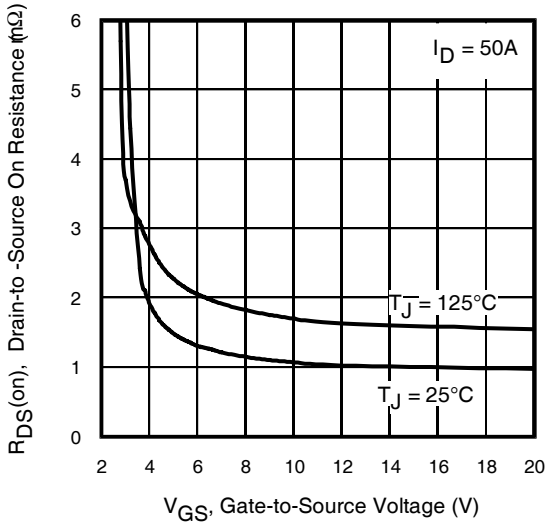
**Fig 9.** Maximum Drain Current Vs. Case (Bottom) Temperature



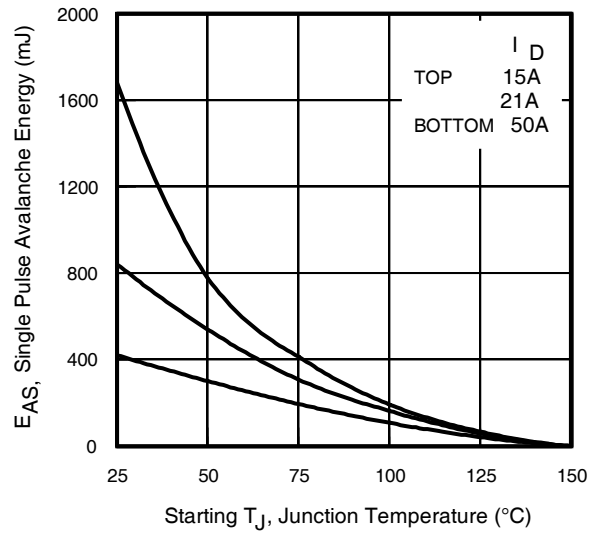
**Fig 10.** Threshold Voltage Vs. Temperature



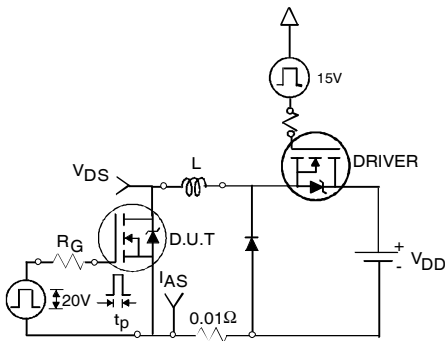
**Fig 11.** Maximum Effective Transient Thermal Impedance, Junction-to-Case (Bottom)



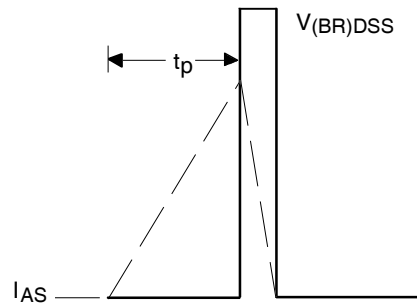
**Fig 12.** On-Resistance vs. Gate Voltage



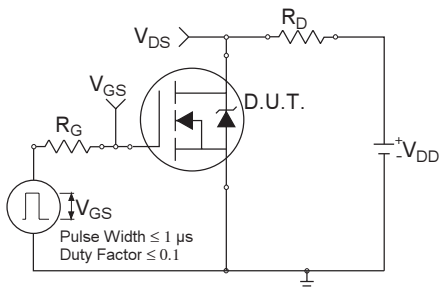
**Fig 13.** Maximum Avalanche Energy vs. Drain Current



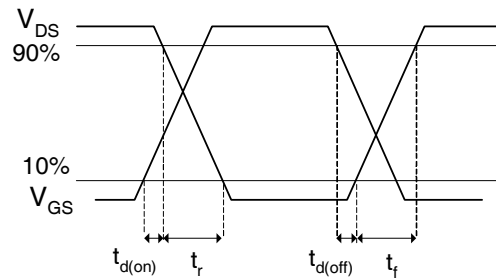
**Fig 14a.** Unclamped Inductive Test Circuit



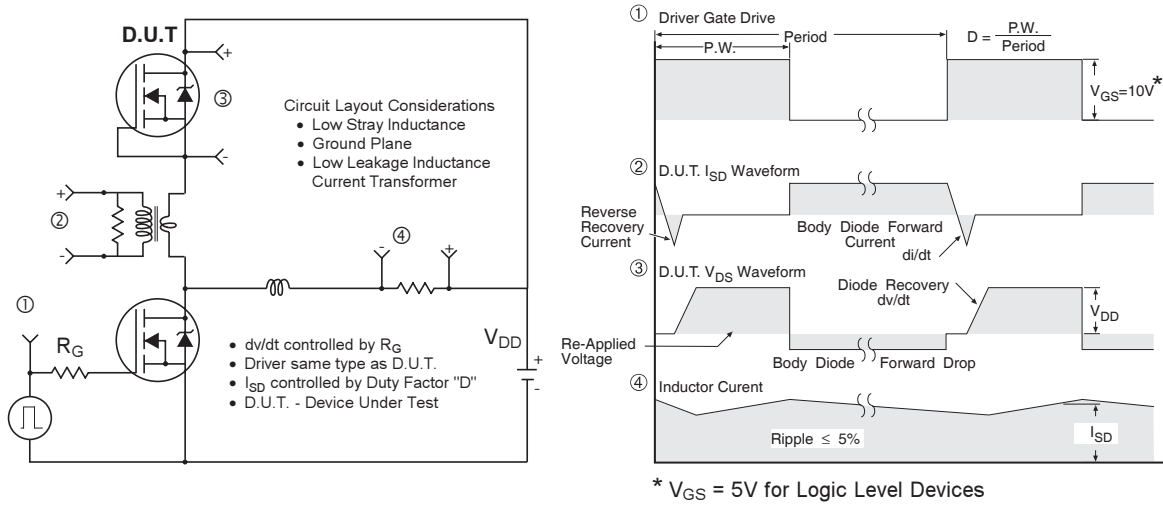
**Fig 14b.** Unclamped Inductive Waveforms



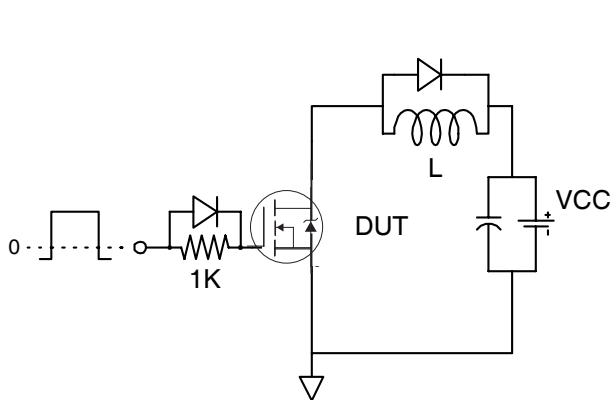
**Fig 15a.** Switching Time Test Circuit



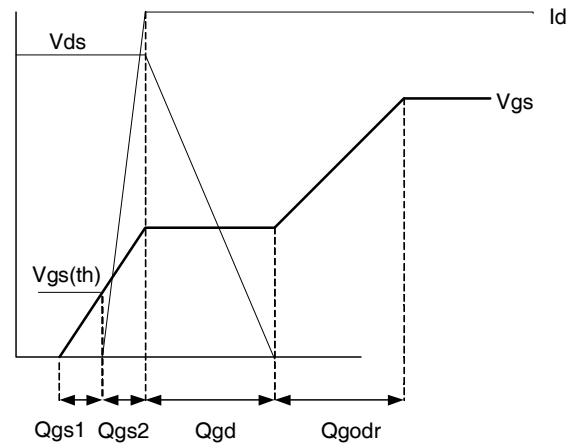
**Fig 15b.** Switching Time Waveforms



**Fig 16. Peak Diode Recovery  $dv/dt$  Test Circuit for N-Channel HEXFET<sup>®</sup> Power MOSFETs**

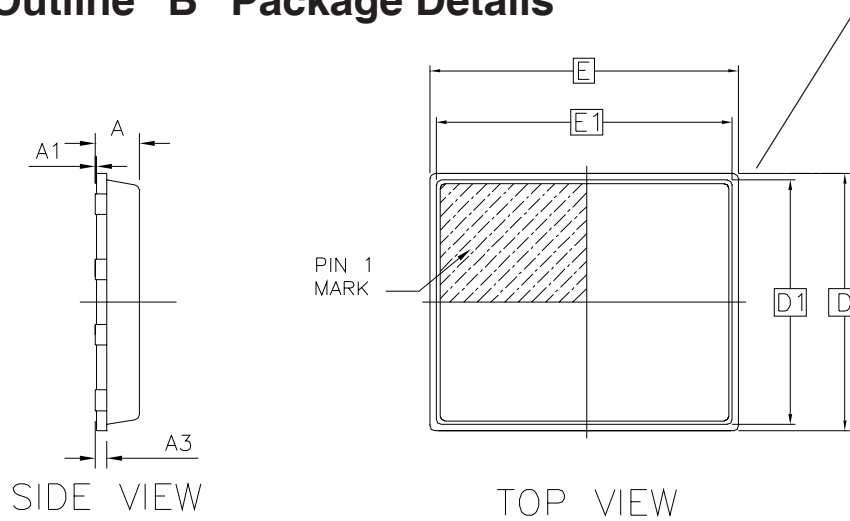


**Fig 17. Gate Charge Test Circuit**

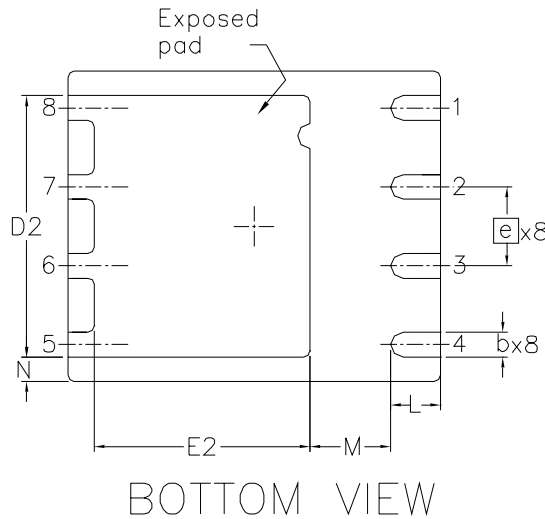


**Fig 18. Gate Charge Waveform**

### PQFN 5x6 Outline "B" Package Details

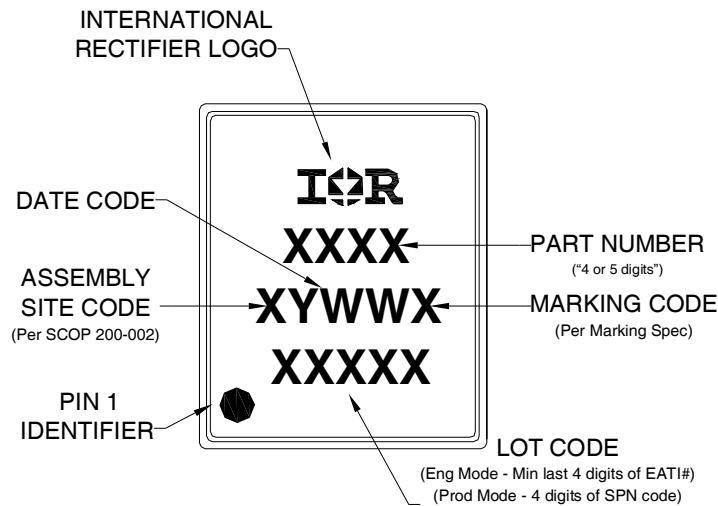


OUTLINE PQFN 5x6B			
DIM SYMBOL	MIN	NOM	MAX
A	0.80	0.83	0.90
A1	0	0.020	0.05
A3		0.20	REF
b	0.35	0.40	0.47
D		5.00	BSC
D1		4.75	BSC
D2	4.10	4.21	4.30
e		1.27	BSC
E		6.00	BSC
E1		5.75	BSC
E2	3.38	3.48	3.58
L	0.70	0.80	0.90
M		1.30	REF
N		0.40	REF



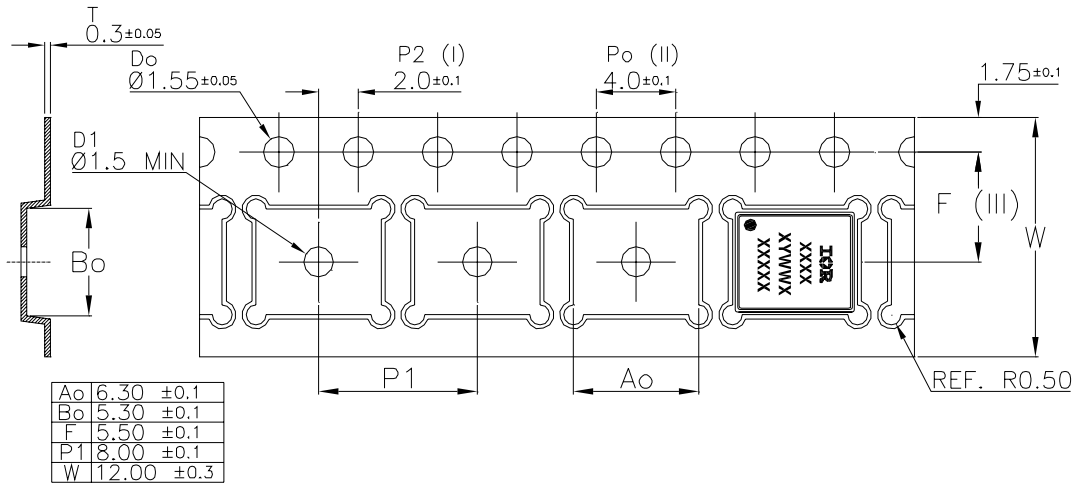
For footprint and stencil design recommendations, please refer to application note AN-1154 at <http://www.irf.com/technical-info/appnotes/an-1154.pdf>

### PQFN 5x6 Outline "B" Part Marking



Note: For the most current drawing please refer to IR website at: <http://www.irf.com/package/>  
[www.irf.com](http://www.irf.com)

## PQFN Tape and Reel



Note: For the most current drawing please refer to IR website at: <http://www.irf.com/package/>

### Qualification information<sup>†</sup>

Qualification level	Industrial <sup>††</sup> (per JEDEC JESD47F <sup>†††</sup> guidelines)	
Moisture Sensitivity Level	PQFN 5mm x 6mm	MSL1 (per JEDEC J-ST-D-020D <sup>†††</sup> )
RoHS compliant	Yes	

<sup>†</sup> Qualification standards can be found at International Rectifier's web site

<http://www.irf.com/product-info/reliability>

<sup>††</sup> Higher qualification ratings may be available should the user have such requirements.

Please contact your International Rectifier sales representative for further information:

<http://www.irf.com/whoto-call/salesrep/>

<sup>†††</sup> Applicable version of JEDEC standard at the time of product release.

### Notes:

- ① Repetitive rating; pulse width limited by max. junction temperature.
- ② Starting  $T_J = 25^\circ\text{C}$ ,  $L = 0.337\text{mH}$ ,  $R_G = 25\Omega$ ,  $I_{AS} = 50\text{A}$ .
- ③ Pulse width  $\leq 400\mu\text{s}$ ; duty cycle  $\leq 2\%$ .
- ④  $R_\theta$  is measured at  $T_J$  of approximately  $90^\circ\text{C}$ .
- ⑤ When mounted on 1 inch square 2 oz copper pad on 1.5x1.5 in. board of FR-4 material.
- ⑥ Calculated continuous current based on maximum allowable junction temperature. Package is limited to 100A by production test capability

Data and specifications subject to change without notice.

International  
**IR** Rectifier

IR WORLD HEADQUARTERS: 233 Kansas St., El Segundo, California 90245, USA Tel: (310) 252-7105

TAC Fax: (310) 252-7903

Visit us at [www.irf.com](http://www.irf.com) for sales contact information.9/2009