

## High Density Mounting Type Photocoupler PC817 Series

■ Features

- Current transfer ratio  
( CTR: MIN. 50% at  $I_F = 5\text{mA}$  ,  $V_{CE}=5\text{V}$ )
- High isolation voltage between input and output

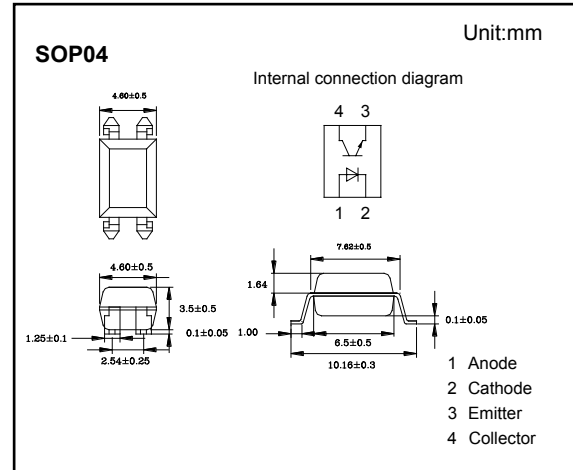

■ Absolute Maximum Ratings  $T_a = 25^\circ\text{C}$

Parameter	Symbol	Rating	Unit
Input Reverse voltage	$V_R$	6	V
Collector - Emitter Output Voltage	$V_{CEO}$	35	
Emitter-Collector Output Voltage	$V_{ECO}$	6	
Isolation Voltage	$V_{ISO}$	5000	$V_{rms}$
Input Forward Current	$I_F$	50	mA
Input Peak Forward Current (Note.1)	$I_{FM}$	1	A
Collector Current - Continuous	$I_C$	50	mA
Input Power Dissipation	$P$	70	mW
Collector Output Power dissipation	$P_C$	150	
Total Power Dissipation	$P_{tot}$	200	
Junction Temperature	$T_J$	125	$^\circ\text{C}$
Soldering temperature	$T_{sol}$	260	
Operating Temperature	$T_{opr}$	-30 to 100	
Storage Temperature Range	$T_{stg}$	-55 to 125	

Note.1:Pulse width  $\leq 100\text{ms}$ , Duty ratio : 0.001



## High Density Mounting Type Photocoupler PC817 Series

■ Electrical Characteristics Ta = 25°C

Parameter	Symbol	Test Conditions	Min	Typ	Max	Unit
Input Forward Voltage	V <sub>F</sub>	I <sub>F</sub> = 20 mA			1.4	V
Input Peak Forward Voltage	V <sub>FM</sub>	I <sub>FM</sub> = 500 mA			3	
Input Reverse Current	I <sub>R</sub>	V <sub>R</sub> = 4 V			10	μA
Collector- emitter cut-off current	I <sub>CEO</sub>	V <sub>CE</sub> = 20 V , I <sub>E</sub> = 0			10	
Collector-emitter saturation voltage	V <sub>CE(sat)</sub>	I <sub>F</sub> = 20mA, I <sub>c</sub> = 1mA		0.1	0.2	V
Isolation resistance	R <sub>ISO</sub>	DC 500V, 40 to 60% RH	5 x 10 <sup>10</sup>	10 <sup>11</sup>		Ω
Current Transfer Ratio	CTR	V <sub>CE</sub> = 5V, I <sub>F</sub> = 5mA	50		600	%
Rise time	t <sub>r</sub>	V <sub>CE</sub> = 2V, I <sub>c</sub> = 2mA, R <sub>L</sub> = 100Ω		4	18	μS
Fall time	t <sub>f</sub>			3	18	
Input Terminal Capacitance	C <sub>i</sub>	V = 0V, f = 1KHz		30	250	pF
Floating Capacitance	C <sub>f</sub>			0.6	1	
Cut-off frequency	f <sub>c</sub>	V <sub>CE</sub> = 5V, I <sub>c</sub> = 2mA, R <sub>L</sub> = 100Ω		80		KHz

■ Classification of CTR(%)

Type	PC817A	PC817B	PC817C	PC817D	PC817
Range	80-160	130-260	200-400	300-600	50-600

■ Typical Characteristics

**Fig. 1 Forward Current vs. Ambient Temperature**

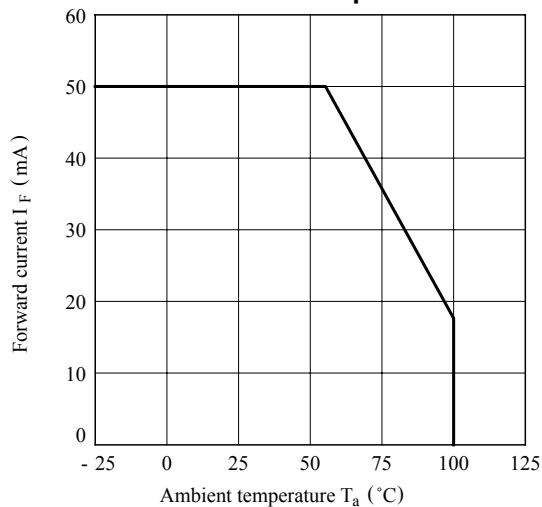

# High Density Mounting Type Photocoupler PC817 Series

■ Typical Characteristics

**Fig. 2 Collector Power Dissipation vs. Ambient Temperature**

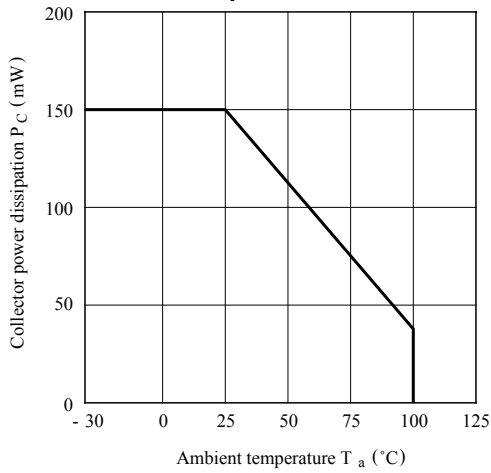

**Fig. 3 Peak Forward Current vs. Duty Ratio**

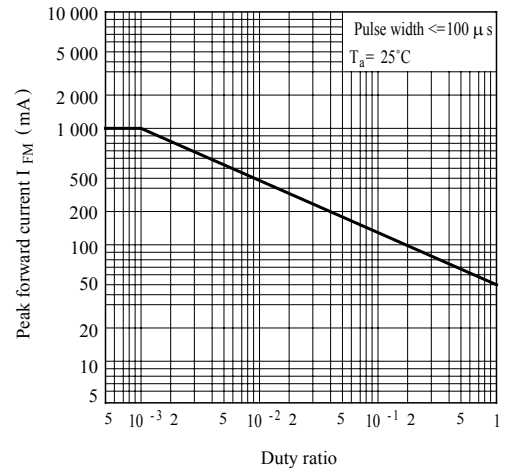

**Fig. 4 Current Transfer Ratio vs. Forward Current**

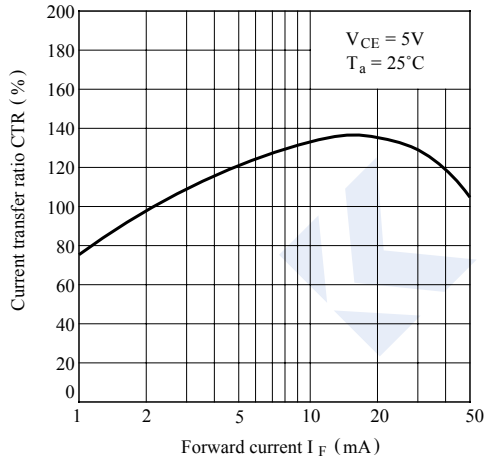

**Fig. 5 Forward Current vs. Forward Voltage**

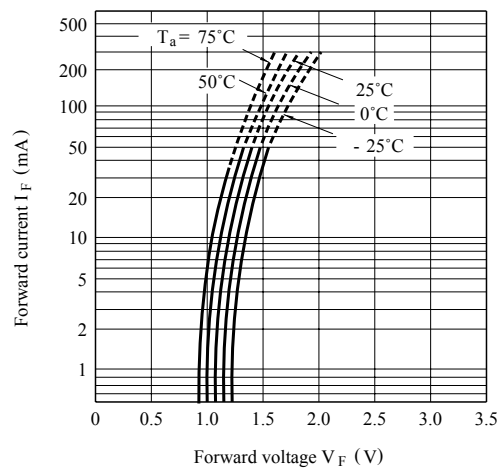

**Fig. 6 Collector Current vs. Collector-emitter Voltage**

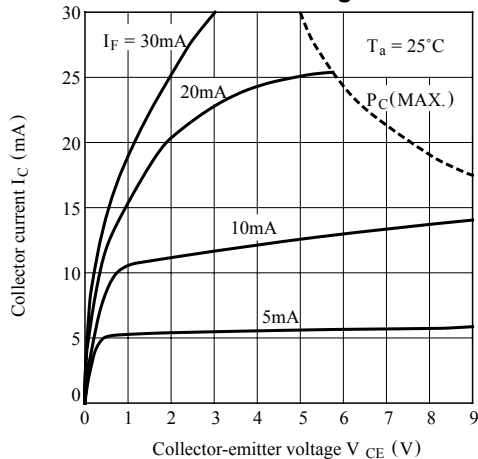

**Fig. 7 Relative Current Transfer Ratio vs. Ambient Temperature**

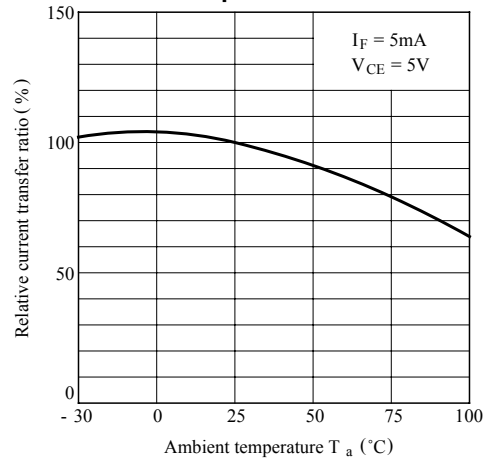

# High Density Mounting Type Photocoupler PC817 Series

■ Typical Characteristics

**Fig. 8 Collector-emitter Saturation Voltage vs. Ambient Temperature**

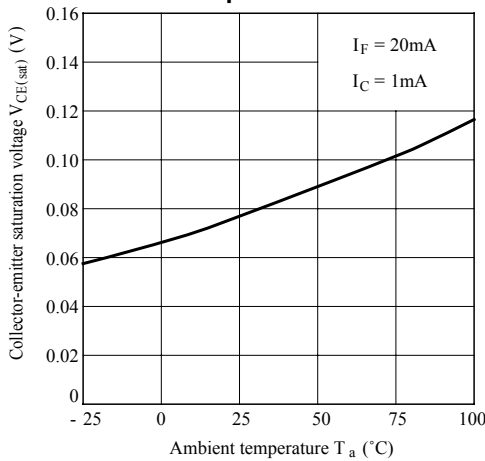

**Fig. 9 Collector Dark Current vs. Ambient Temperature**

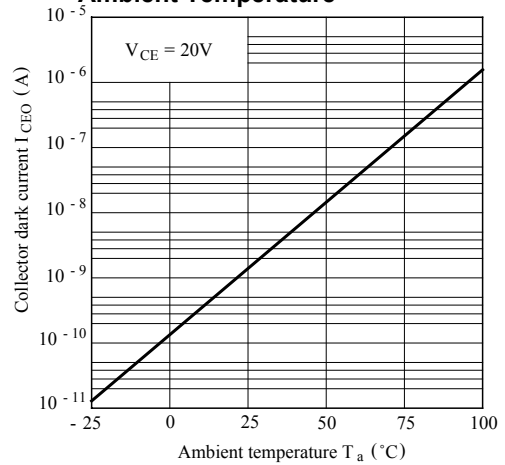

**Fig.10 Response Time vs. Load Resistance**

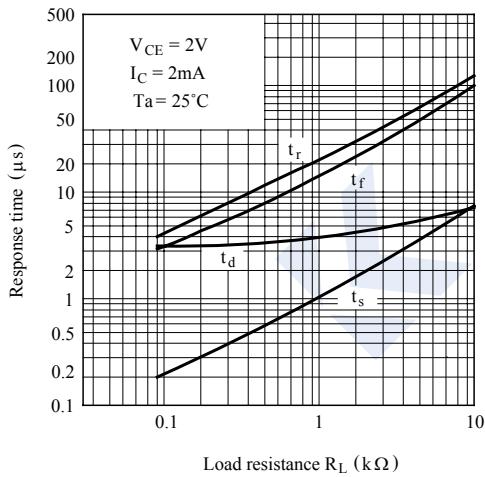

**Fig.11 Frequency Response**

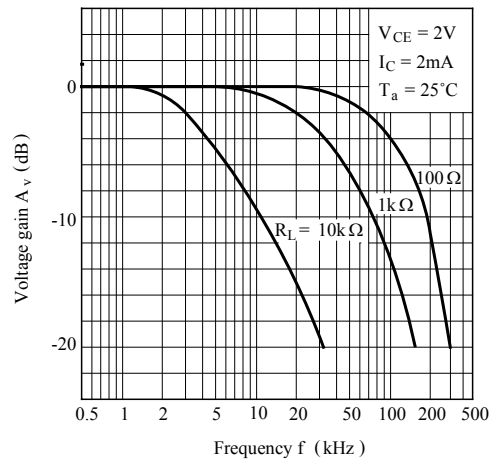

**Test Circuit for Response Time**

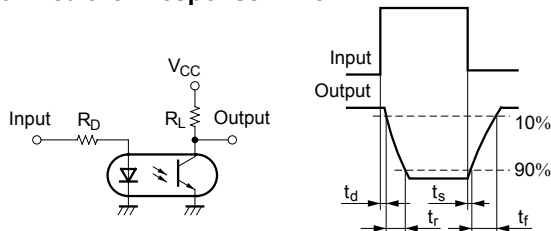

**Test Circuit for Frequency Response**

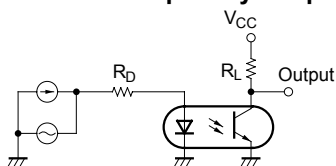

**Fig.12 Collector-emitter Saturation Voltage vs. Forward Current**

