

VOLTAGE RANGE: 2.4 - 39V
POWER: 0.5Watts

Features

- Planar Die Construction
- 500mW Power Dissipation on Ceramic PCB
General Purpose, Medium Current
- Ideally Suited for Automated Assembly Processes

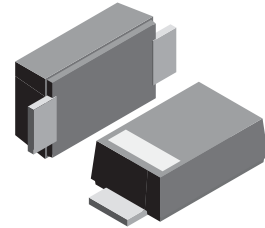

Mechanical Data

- Case: SOD-123FL
plastic body over passivated junction
- Terminals : Plated axial leads,
- solderable per MIL-STD-750, Method 2026
- Polarity : Color band denotes cathode end
- Mounting Position : Any
- Weight:0.0007 ounce, 0.02 grams

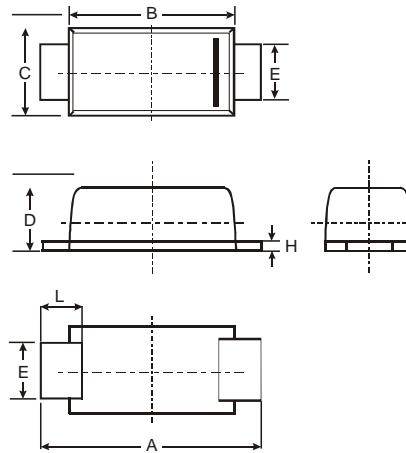

SOD-123FL			
Dim	Min	Max	Typ
A	3.50	3.80	3.65
B	2.60	2.90	2.75
C	1.70	1.90	1.80
D	0.09	1.10	1.00
E	0.08	1.10	0.095
H	0.12	0.20	0.16
L	0.07	0.09	0.08
All Dimensions in mm			

Maximum Ratings $T_A = 25^\circ\text{C}$ unless otherwise specified

Characteristic	Symbol	Value	Unit
Forward Voltage (Note 2) @ $I_F = 10\text{mA}$	V_F	0.9	V
Power Dissipation (Note 1)	P_d	500	mW
Thermal Resistance, Junction to Ambient Air (Note 1)	$R_{\theta JA}$	305	$^\circ\text{C/W}$
Operating and Storage Temperature Range	T_j, T_{STG}	-65 to +150	$^\circ\text{C}$

- Notes: 1. Device mounted on ceramic PCB; 7.6mm x 9.4mm x 0.87mm with pad areas 25mm².
 2. Short duration test pulse used to minimize self-heating effect.



Electrical Characteristics @ T_A = 25°C unless otherwise specified

Type Number	Zener Voltage Range (Note 2)				Maximum Zener Impedance (Note 3)			Maximum Reverse Current (Note 2)		Typical Temperature Coefficient @ I _{ZTC} mV/°C		Test Current I _{ZTC} mA
	V _Z @ I _{ZT}			I _{ZT}	Z _{ZT} @ I _{ZT}	Z _{ZK} @ I _{ZK}	I _{ZK}	I _R	@ V _R	Min	Max	
	Nom (V)	Min (V)	Max (V)	mA	Ω		mA	uA	V			
BZT52C2V4	2.4	2.2	2.6	5	100	600	1.0	50	1.0	-3.5	0	5
BZT52C2V7	2.7	2.5	2.9	5	100	600	1.0	20	1.0	-3.5	0	5
BZT52C3V0	3.0	2.8	3.2	5	95	600	1.0	10	1.0	-3.5	0	5
BZT52C3V3	3.3	3.1	3.5	5	95	600	1.0	5.0	1.0	-3.5	0	5
BZT52C3V6	3.6	3.4	3.8	5	90	600	1.0	5.0	1.0	-3.5	0	5
BZT52C3V9	3.9	3.7	4.1	5	90	600	1.0	3.0	1.0	-3.5	0	5
BZT52C4V3	4.3	4.0	4.6	5	90	600	1.0	3.0	1.0	-3.5	0	5
BZT52C4V7	4.7	4.4	5.0	5	80	500	1.0	3.0	2.0	-3.5	0.2	5
BZT52C5V1	5.1	4.8	5.4	5	60	480	1.0	2.0	2.0	-2.7	1.2	5
BZT52C5V6	5.6	5.2	6.0	5	40	400	1.0	1.0	2.0	-2	2.5	5
BZT52C6V2	6.2	5.8	6.6	5	10	150	1.0	3.0	4.0	0.4	3.7	5
BZT52C6V8	6.8	6.4	7.2	5	15	80	1.0	2.0	4.0	1.2	4.5	5
BZT52C7V5	7.5	7.0	7.9	5	15	80	1.0	1.0	5.0	2.5	5.3	5
BZT52C8V2	8.2	7.7	8.7	5	15	80	1.0	0.7	5.0	3.2	6.2	5
BZT52C9V1	9.1	8.5	9.6	5	15	100	1.0	0.5	6.0	3.8	7.0	5
BZT52C10	10	9.4	10.6	5	20	150	1.0	0.2	7.0	4.5	8.0	5
BZT52C11	11	10.4	11.6	5	20	150	1.0	0.1	8.0	5.4	9.0	5
BZT52C12	12	11.4	12.7	5	25	150	1.0	0.1	8.0	6.0	10.0	5
BZT52C13	13	12.4	14.1	5	30	170	1.0	0.1	8.0	7.0	11.0	5
BZT52C15	15	13.8	15.6	5	30	200	1.0	0.1	10.5	9.2	13.0	5
BZT52C16	16	15.3	17.1	5	40	200	1.0	0.1	11.2	10.4	14.0	5
BZT52C18	18	16.8	19.1	5	45	225	1.0	0.1	12.6	12.4	16.0	5
BZT52C20	20	18.8	21.2	5	55	225	1.0	0.1	14.0	14.4	18.0	5
BZT52C22	22	20.8	23.3	5	55	250	1.0	0.1	15.4	16.4	20.0	5
BZT52C24	24	22.8	25.6	5	70	250	1.0	0.1	16.8	18.4	22.0	5
BZT52C27	27	25.1	28.9	2	80	300	0.5	0.1	18.9	21.4	25.3	2
BZT52C30	30	28.0	32.0	2	80	300	0.5	0.1	21.0	24.4	29.4	2
BZT52C33	33	31.0	35.0	2	80	325	0.5	0.1	23.1	27.4	33.4	2
BZT52C36	36	34.0	38.0	2	90	350	0.5	0.1	25.2	30.4	37.4	2
BZT52C39	39	37.0	41.0	2	130	350	0.5	0.1	27.3	33.4	41.2	2

- Notes:
1. Device mounted on ceramic PCB; 7.6mm x 9.4mm x 0.87mm with pad areas 25mm².
 2. Short duration test pulse used to minimize self-heating effect.
 3. f = 1kHz.

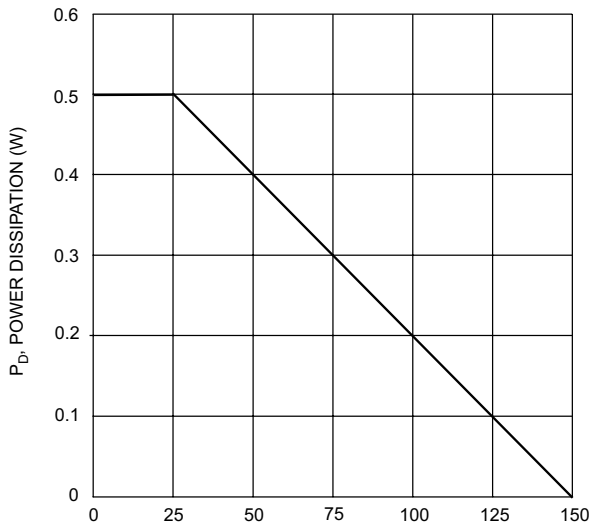

Fig. 1 Power Dissipation vs Ambient Temperature

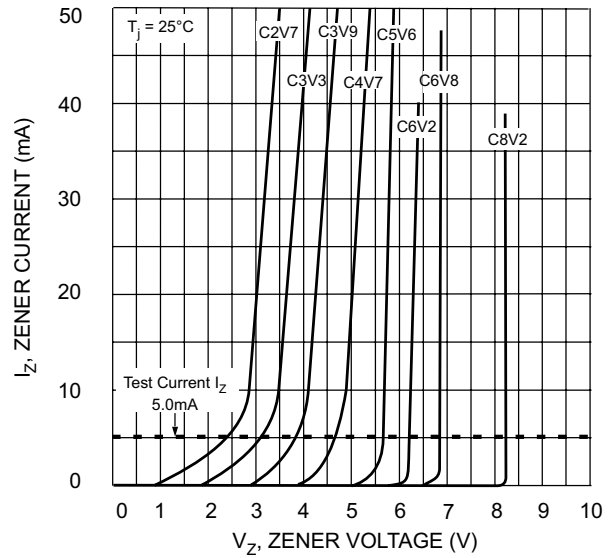

Fig. 2 Zener Breakdown Characteristics

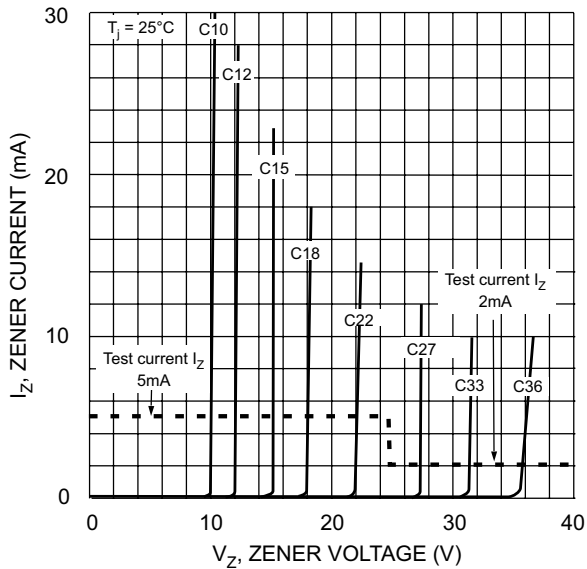

Fig. 3 Zener Breakdown Characteristics

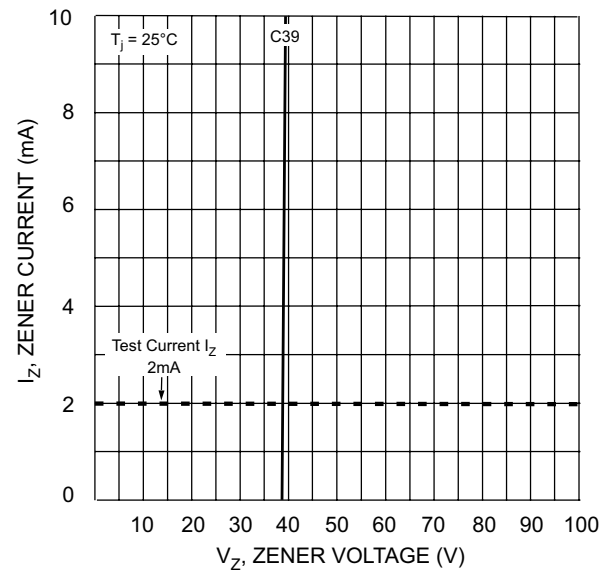

Fig. 4 Zener Breakdown Characteristics

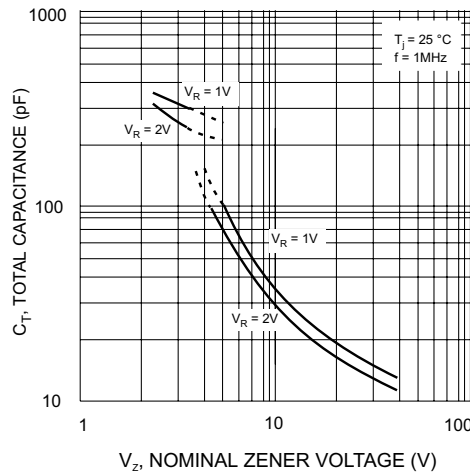

Fig. 5 Total Capacitance vs Nominal Zener Voltage