

VOLTAGE RANGE: 50 - 1000V
CURRENT: 3.0 A

Features

- Diffused Junction
- Low Forward Voltage Drop
- High Current Capability
- High Reliability
- High Surge Current Capability

Mechanical Data

- Case: DO-201AD, Molded Plastic
- Terminals: Plated Leads Solderable per MIL-STD-202, Method 208
- Polarity: Cathode Band
- Weight: 1.2 grams (approx.)
- Mounting Position: Any
- Marking: Type Number

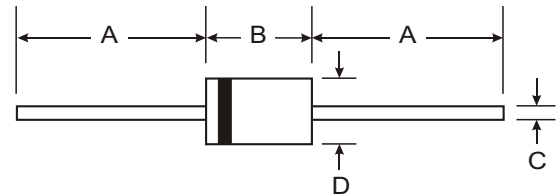
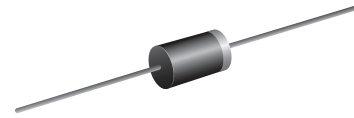

DO-201AD		
Dim	Min	Max
A	25.40	—
B	8.50	9.53
C	0.96	1.06
D	4.80	5.21
All Dimensions in mm		

Maximum Ratings and Electrical Characteristics T_A = 25°C unless otherwise specified

Single phase, half wave, 60Hz, resistive or inductive load. For capacitive load, derate current by 20%.

Characteristic	Symbol	UF 5400	UF 5401	UF 5402	UF 5403	UF 5404	UF 5406	UF 5407	UF 5408	Unit	
Peak Repetitive Reverse Voltage	V _{RRM}	50	100	200	300	400	600	800	1000	V	
Working Peak Reverse Voltage	V _{VRM}										
DC Blocking Voltage	V _R										
RMS Reverse Voltage	V _{R(RMS)}	35	70	140	210	280	420	560	700	V	
Average Rectified Output Current (Note 1) @T _A = 55°C	I _O	3.0								A	
Non-Repetitive Peak Forward Surge Current 8.3ms Single half sine-wave superimposed on rated load (JEDEC Method)	I _{FSM}	150								A	
Forward Voltage @I _F = 3.0A	V _{FM}	1.0			1.3		1.7			V	
Peak Reverse Current @T _A = 25°C	I _{RM}	10								μA	
At Rated DC Blocking Voltage @T _A = 100°C		100									
Reverse Recovery Time (Note 2)	t _{rr}	50					75				nS
Typical Junction Capacitance (Note 3)	C _j	80					50				pF
Operating Temperature Range	T _j	-65 to +125								°C	
Storage Temperature Range	T _{STG}	-65 to +150								°C	

Note: 1. Leads maintained at ambient temperature at a distance of 9.5mm from the case
 2. Measured with I_F = 0.5A, I_R = 1.0A, I_{RR} = 0.25A. See figure 5.
 3. Measured at 1.0 MHz and applied reverse voltage of 4.0V D.C.

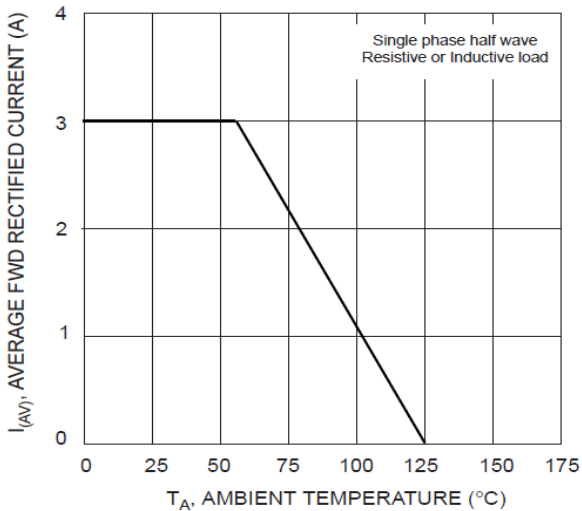

Fig. 1 Forward Current Derating Curve

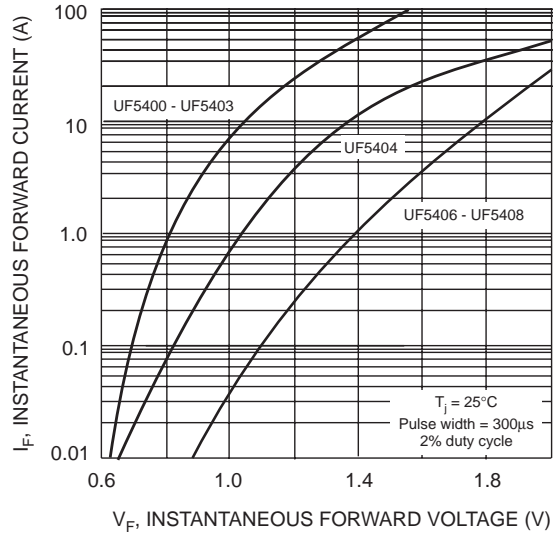

Fig. 2 Typical Forward Characteristics

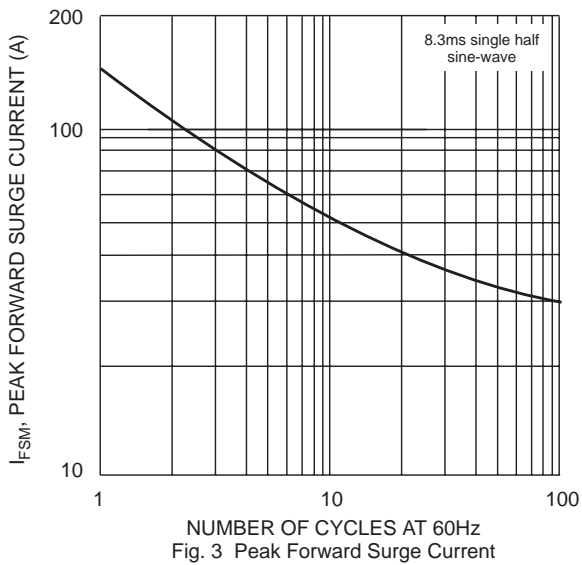

Fig. 3 Peak Forward Surge Current

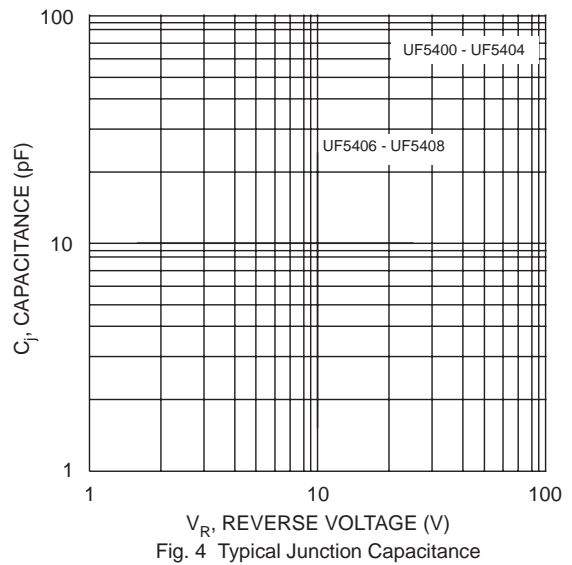
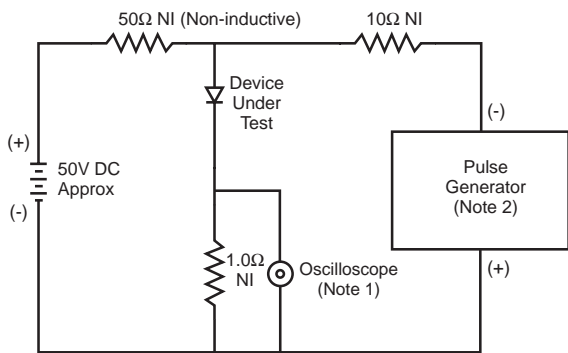
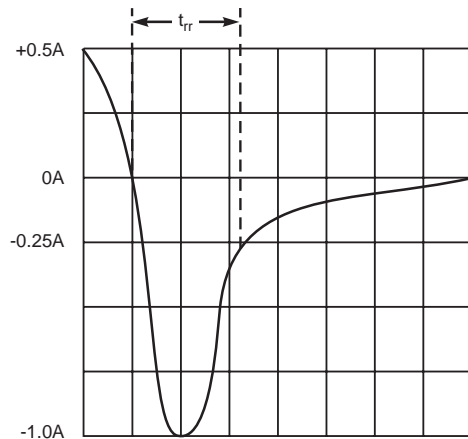

Fig. 4 Typical Junction Capacitance



- Notes:
1. Rise Time = 7.0ns max. Input Impedance = 1.0MΩ, 22pF.
 2. Rise Time = 10ns max. Input Impedance = 50Ω.



Set time base for 5/10ns/cm

Fig. 5 Reverse Recovery Time Characteristic and Test Circuit