

VOLTAGE RANGE: 50 - 1000V
CURRENT: 1.0 A

Features

- Glass Passivated Die Construction
- Diffused Junction
- Ultra-Fast Recovery Time for High Efficiency
- Low Forward Voltage Drop, High Current
- Capability, and Low Power Loss
- Ideally Suited for Automated Assembly
- Plastic Material: UL Flammability Classification Rating 94V-0

Mechanical Data

- Case: SMA(DO-214AC)Molded Plastic
- Terminals: Solder Plated Terminal - Solderable per MIL-STD-202, Method 208
- Polarity: Cathode Band or Cathode Notch
- Marking: Type Number
- Weight: 0.064 grams (approx.)
- Mounting Position: Any

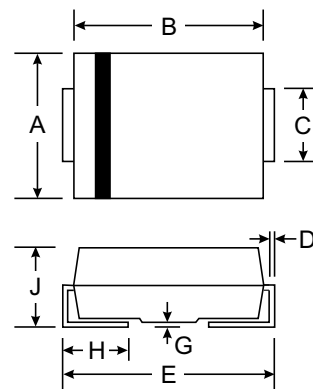

SMA(DO-214AC)		
Dim	Min	Max
A	2.29	2.92
B	4.00	4.60
C	1.27	1.63
D	0.15	0.31
E	4.80	5.59
G	0.10	0.20
H	0.76	1.52
J	2.01	2.62
All Dimensions in mm		

Maximum Ratings and Electrical Characteristics T_A = 25°C unless otherwise specified

Single phase, half wave, 60Hz, resistive or inductive load. For capacitive load, derate current by 20%.

Characteristic	Symbol	US1A	US1B	US1D	US1G	US1J	US1K	US1M	Unit
Peak Repetitive Reverse Voltage Working Peak Reverse Voltage DC Blocking Voltage	V_{RRM} V_{RWM} V_R	50	100	200	400	600	800	1000	V
RMS Reverse Voltage	$V_{R(RMS)}$	35	70	140	280	420	560	700	V
Average Rectified Output Current @ T _T = 75°C	I _O	1.0							A
Non-Repetitive Peak Forward Surge Current 8.3ms Single half sine-wave Superimposed on Rated Load (JEDEC Method)	I _{FSM}	30							A
Forward Voltage Drop @ I _F = 1.0A	V _{FM}	1.0			1.3	1.7			V
Peak Reverse Current @ T _A = 25°C at Rated DC Blocking Voltage @ T _A = 100°C	I _{RM}	5.0				100			μA
Reverse Recovery Time (Note 2)	t _{rr}	50				75			ns
Typical Junction Capacitance (Note 1)	C _j	20				10			pF
Typical Thermal Resistance, Junction to Terminal	R _{θJT}	30							°C/W
Operating and Storage Temperature Range	T _j , T _{STG}	-65 to +150							°C

Notes: 1. Measured at 1.0MHz and applied reverse voltage of 4.0V DC.
 2. Measured with I_F = 0.5A, I_R = 1.0A, I_{rr} = 0.25A.

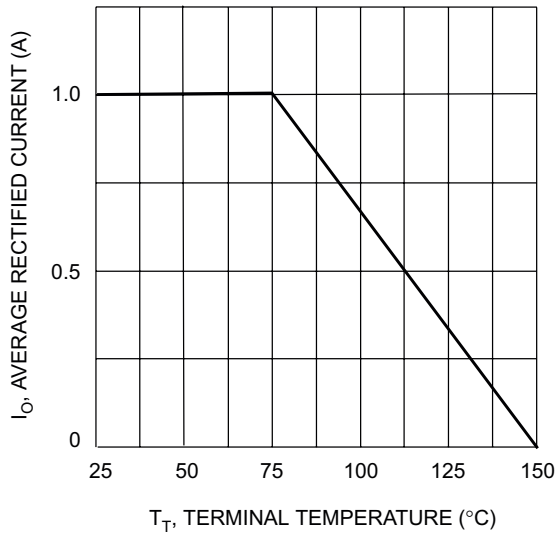

Fig. 1 Forward Current Derating Curve

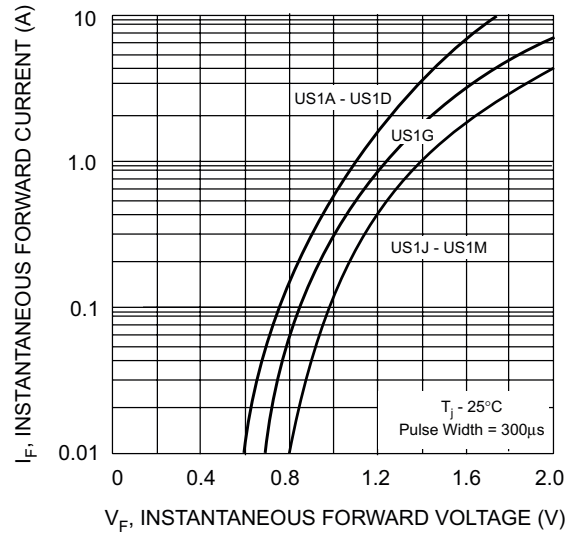

Fig. 2 Typical Forward Characteristics

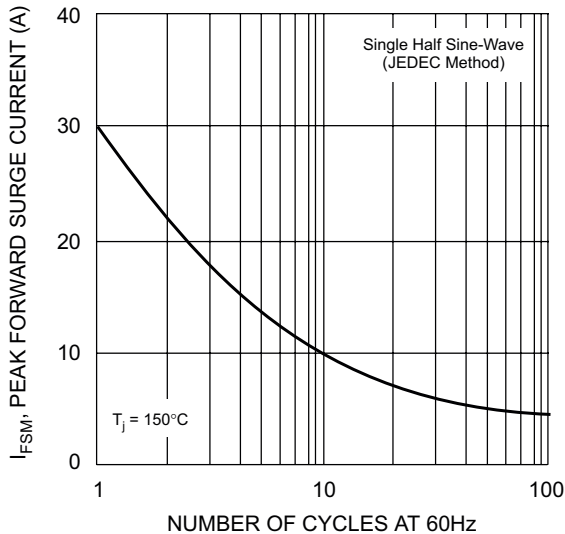

Fig. 3 Forward Surge Current Derating Curve

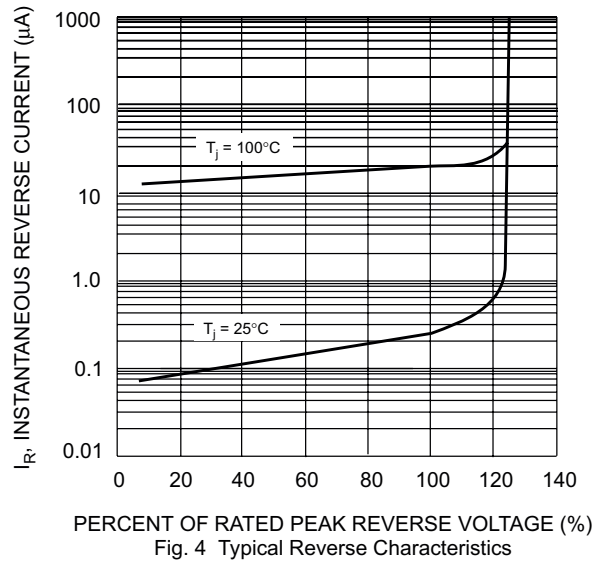
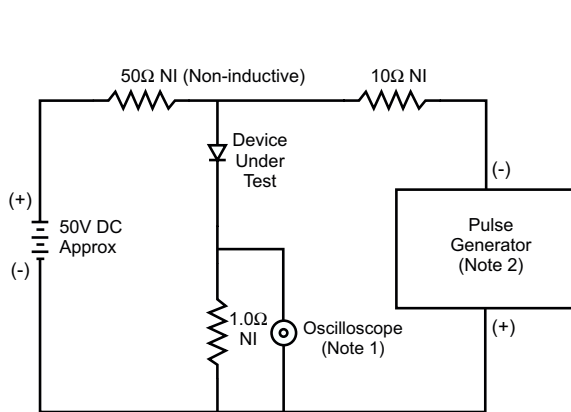
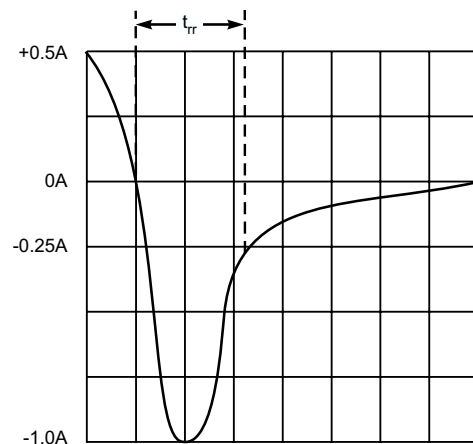

Fig. 4 Typical Reverse Characteristics



- Notes:
1. Rise Time = 7.0ns max. Input Impedance = 1.0MΩ, 22pF.
 2. Rise Time = 10ns max. Input Impedance = 50Ω.



Set time base for 50/100 ns/cm

Fig. 5 Reverse Recovery Time Characteristic and Test Circuit