

VOLTAGE RANGE: 50 - 600V
CURRENT: 2.0 A

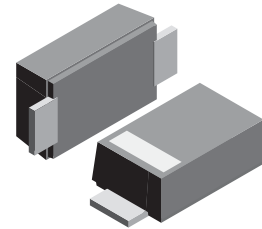

Features

- Glass Passivated Die Construction
- Ideally Suited for Automatic Assembly
- Low Forward Voltage Drop, High Efficiency
- Low Power Loss
- Super-Fast Recovery Time
- Plastic Case Material has UL Flammability Classification Rating 94V-0

Mechanical Data

- Case: SMBF, Molded Plastic
- Terminals: Solder Plated, Solderable per MIL-STD-750, Method 2026
- Polarity: Cathode Band or Cathode Notch
- Marking: Type Number
- Weight: 0.0018 ounces, 0.05grams

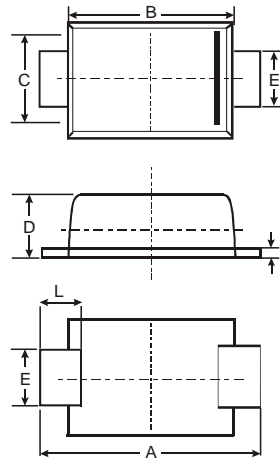

SMBF			
Dim	Min	Max	Typ
A	5.45	5.55	5.50
B	4.27	4.33	4.30
C	3.57	3.63	3.60
D	1.32	1.38	1.35
E	1.96	2.00	1.98
H	0.019	0.021	0.20
L	0.73	0.77	0.75
All Dimensions in mm			

Maximum Ratings and Electrical Characteristics T_A = 25°C unless otherwise specified

Single phase, half wave, 60Hz, resistive or inductive load. For capacitive load, derate current by 20%.

Characteristic	Symbol	ES2AF	ES2BF	ES2CF	ES2DF	ES2EF	ES2GF	ES2JF	Unit
Peak Repetitive Reverse Voltage Working Peak Reverse Voltage DC Blocking Voltage	V _{RRM} V _{RWM} V _R	50	100	150	200	300	400	600	V
RMS Reverse Voltage	V _{R(RMS)}	35	70	105	140	210	280	420	V
Average Rectified Output Current @T _L = 75 °C	I _O	2.0							A
Non-Repetitive Peak Forward Surge Current 8.3ms Single half sine-wave superimposed on rated load (JEDEC Method)	I _{FSM}	50							A
Forward Voltage @I _F = 2.0A	V _{FM}	0.95			1.25		1.7		V
Peak Reverse Current @T _A = 25°C At Rated DC Blocking Voltage @T _A = 100°C	I _{RM}	5.0 200							μA
Reverse Recovery Time (Note 1)	t _{rr}	35							nS
Typical Junction Capacitance (Note 2)	C _j	62							pF
Typical Thermal Resistance (Note 3)	R _{θJL}	40							°C/W
Operating and Storage Temperature Range	T _j , T _{STG}	-65 to +150							°C

Note: 1. Measured with I_F = 0.5A, I_R = 1.0A, I_{rr} = 0.25A. See figure 5.
 2. Measured at 1.0 MHz and applied reverse voltage of 4.0 V DC.
 3. Mounted on P.C. Board with 8.0mm² land area.



RATING AND CHARACTERISTIC CURVES ES2AF THRU ES2JF

Fig. 1 - REVERSE RECOVERY TIME CHARACTERISTIC AND TEST CIRCUIT DIAGRAM ES1A THRU ES1G

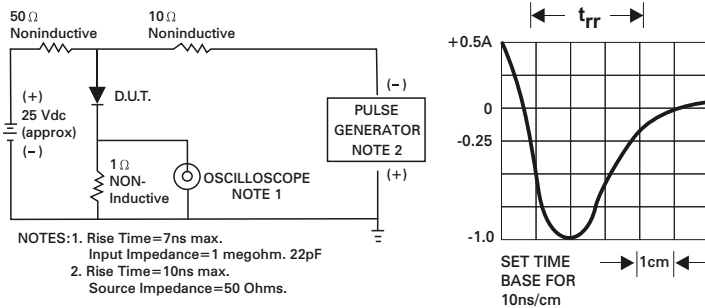

Fig. 2 - MAXIMUM AVERAGE FORWARD CURRENT RATING

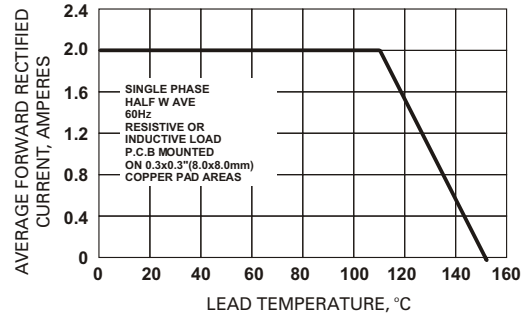

Fig. 3 - TYPICAL REVERSE CHARACTERISTICS

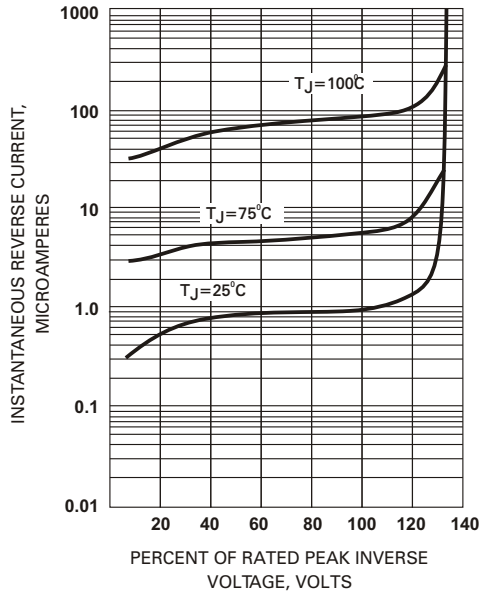

Fig. 4 - TYPICAL FORWARD CHARACTERISTICS

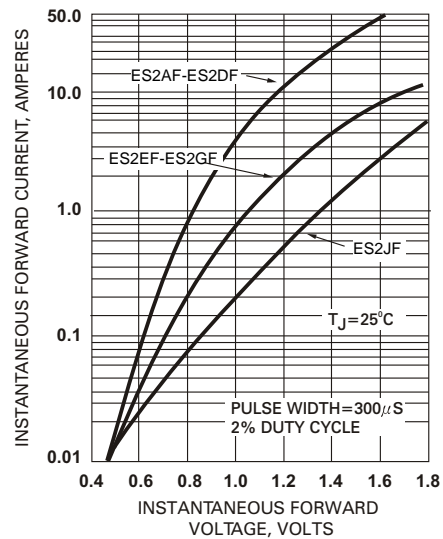

Fig. 5 - MAXIMUM NON-REPETITIVE PEAK FORWARD SURGE CURRENT

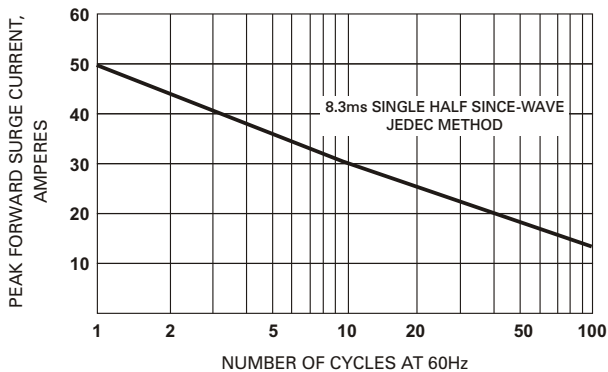

Fig. 6 - TYPICAL JUNCTION CAPACITANCE

