

VOLTAGE RANGE: 50 - 1000V

CURRENT: 2.0 A

Features

- Diffused Junction
- Low Forward Voltage Drop
- High Reliability
- High Surge Current Capability

Mechanical Data

- Case: DO-15 Molded Plastic
- Terminals: Plated Leads Solderable per MIL-STD-202, Method 208
- Polarity: Cathode Band
- Weight: 0.40 grams (approx.)
- Mounting Position: Any
- Marking: Type Number

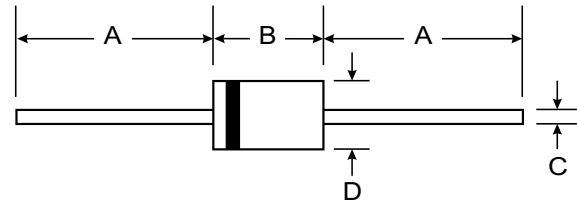
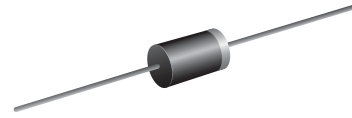

DO-15		
Dim	Min	Max
A	25.40	—
B	5.50	7.62
C	0.686	0.889
D	2.60	3.60
All Dimensions in mm		

Maximum Ratings and Electrical Characteristics T_A = 25°C unless otherwise specified

Single phase, half wave, 60Hz, resistive or inductive load. For capacitive load, derate current by 20%.

Characteristic	Symbol	PG201	PG202	PG203	PG204	PG206	PG208	PG2010	Unit
Peak Repetitive Reverse Voltage	V _{RRM}								V
Working Peak Reverse Voltage	V _{RWM}	50	100	200	400	600	800	1000	
DC Blocking Voltage	V _R								
RMS Reverse Voltage	V _{R(RMS)}	35	70	140	280	420	560	700	V
Average Rectified Output Current (Note 1) <small>@T_A = 55°C</small>	I _O	2.0							A
Non-Repetitive Peak Forward Surge Current 8.3ms Single half sine-wave superimposed on rated load (JEDEC Method)	I _{FSM}	60							A
Forward Voltage <small>@I_F = 2.0A</small>	V _{FM}	1.2							V
Peak Reverse Current <small>@T_A = 25°C</small> At Rated DC Blocking Voltage <small>@T_A = 100°C</small>	I _{RM}	5.0 100							μA
Reverse Recovery Time (Note 2)	t _{rr}	150				250	500		nS
Typical Junction Capacitance (Note 3)	C _j	30							pF
Operating Temperature Range	T _j	-65 to +125							°C
Storage Temperature Range	T _{STG}	-65 to +150							°C

Note: 1. Leads maintained at ambient temperature at a distance of 9.5mm from the case

2. Measured with I_F = 0.5A, I_R = 1.0A, I_{RR} = 0.25A. See figure 5.

3. Measured at 1.0 MHz and applied reverse voltage of 4.0V D.C.

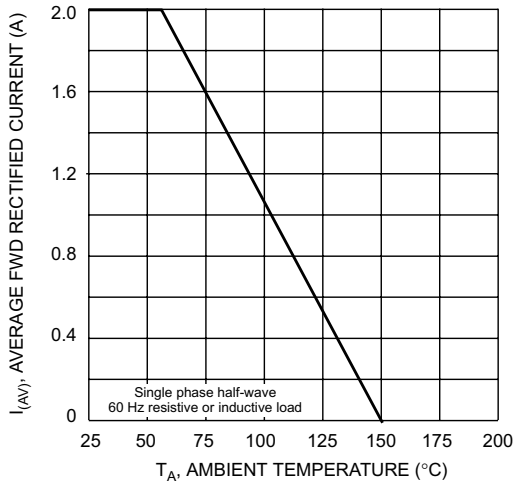

Fig. 1 Forward Derating Curve

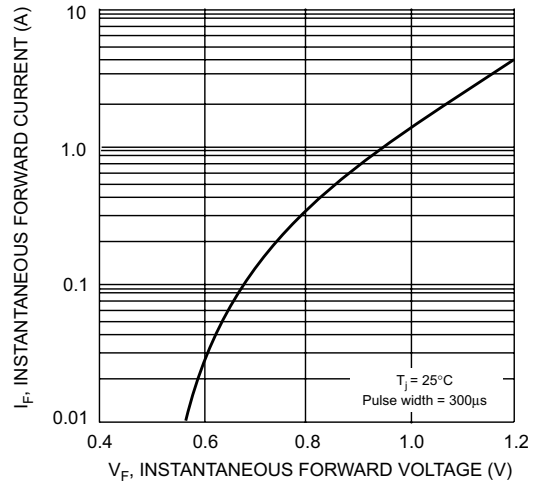

Fig. 2 Typical Forward Characteristics

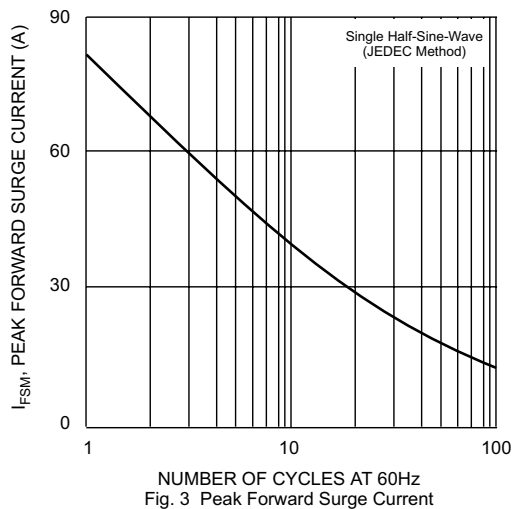

Fig. 3 Peak Forward Surge Current

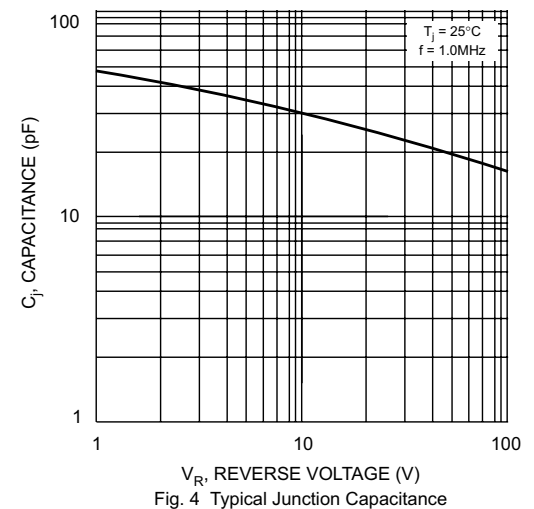
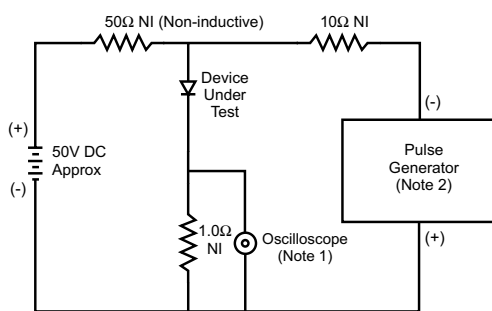
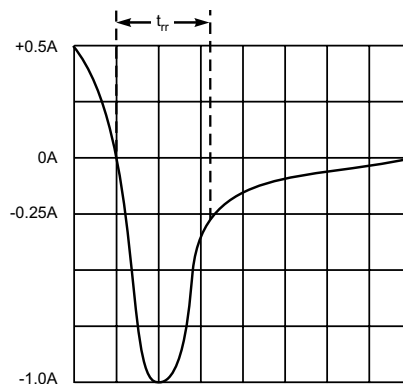

Fig. 4 Typical Junction Capacitance



- Notes:
1. Rise Time = 7.0ns max. Input Impedance = 1.0MΩ, 22pF.
 2. Rise Time = 10ns max. Input Impedance = 50Ω.



Set time base for 50/100 ns/cm

Fig. 5 Reverse Recovery Time Characteristic and Test Circuit