

VOLTAGE RANGE: 50 - 1000V
CURRENT: 1.0 A

Features

- Glass Passivated Die Construction
- Ideally Suited for Automatic Assembly
- Low Forward Voltage Drop, High Efficiency
- Low Power Loss
- Fast Recovery Time
- Plastic Case Material has UL Flammability

Classification Rating 94V-O

Mechanical Data

- Case: SMA Molded Plastic
- Terminals: Solder Plated, Solderable per MIL-STD-750, Method 2026
- Polarity: Cathode Band or Cathode Notch
- Marking: Type Number
- Weight: 0.064 grams (approx.)

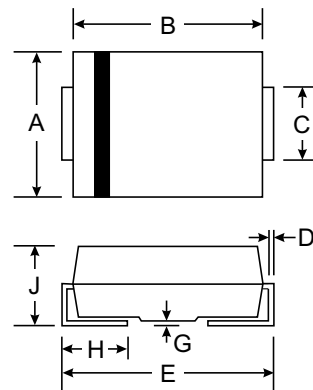

SMA		
Dim	Min	Max
A	2.29	2.92
B	4.00	4.60
C	1.27	1.63
D	0.15	0.31
E	4.80	5.59
G	0.10	0.20
H	0.76	1.52
J	2.01	2.62
All Dimensions in mm		

Maximum Ratings and Electrical Characteristics

Ratings at 25°C ambient temperature unless otherwise specified. Single phase, half wave, 60Hz resistive or inductive load.

	Unit	RGF1A	RGF1B	RGF1D	RGF1G	RGF1J	RGF1K	RGF1M	Unit
Maximum Recurrent Peak Reverse Voltage	V_{RRM}	50	100	200	400	600	800	1000	V
Maximum RMS Voltage	V_{RMS}	35	70	140	280	420	560	700	V
Maximum DC Blocking Voltage	V_{DC}	50	100	200	400	600	800	1000	V
Maximum Average Forward Rectified Current @ $T_A = 75^\circ\text{C}$	$I_{(AV)}$	1.0							A
Peak Forward Surge Current 8.3 ms single half sine-wave superimposed on rated load (JEDEC Method)	I_{FSM}	30							A
Maximum Instantaneous Forward Voltage at 1.0 A	V_F	1.3							V
Maximum DC Reverse Current at Rated DC Blocking Voltage @ $T_A = 25^\circ\text{C}$ @ $T_A = 125^\circ\text{C}$	I_R	5.0							μA
Maximum Full Load Reverse Current Full Cycle Average @ $T_A = 75^\circ\text{C}$		100							
Maximum Reverse Recovery Time (See Note 1)	t_{rr}	150			250	500	500		ns
Maximum Thermal Resistance (See Note 2)	$R_{\theta JL}$	30							$^\circ\text{C}/\text{W}$
Typical Junction Capacitance (See Note 3)	C_J	15							pF
Operating and Storage Temperature Rating	T_J, T_{STG}	-65 to +175							$^\circ\text{C}$

- Notes:
1. Reverse Recovery Test Conditions: $I_F = 0.5\text{A}$, $I_R = 1\text{A}$, $I_{RR} = 0.25\text{A}$
 2. Thermal Resistance from junction to lead with 6.0mm² copper pads
 3. Measured at 1.0MHz and applied reverse voltage of 4.0V

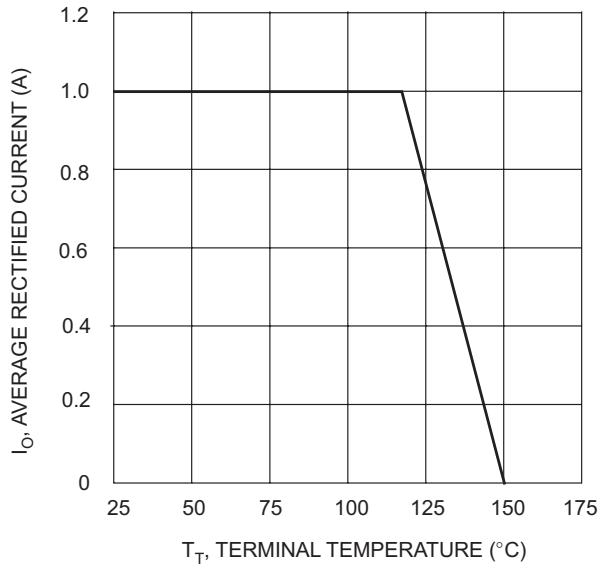

T_T , TERMINAL TEMPERATURE (°C)
Fig. 1 Forward Current Derating Curve

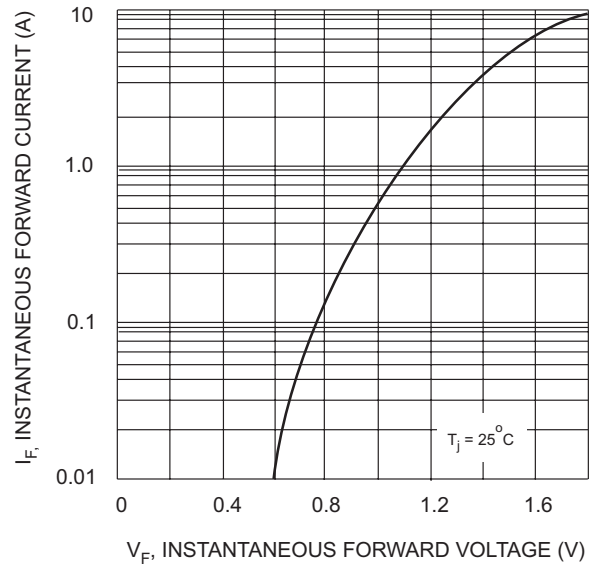

V_F , INSTANTANEOUS FORWARD VOLTAGE (V)
Fig. 2 Typical Forward Characteristics

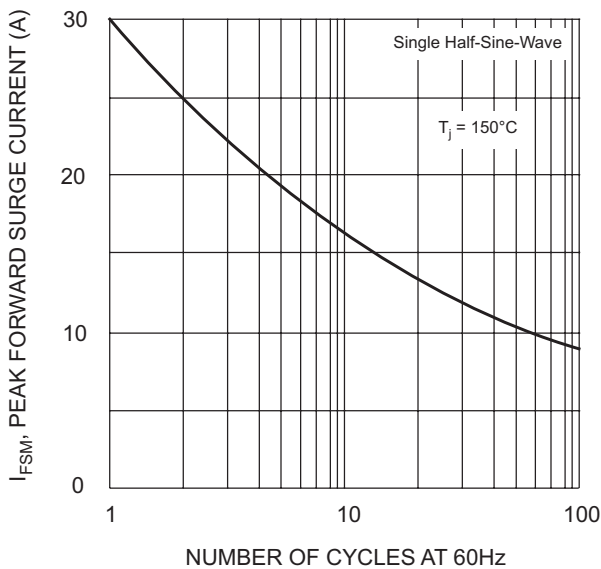

NUMBER OF CYCLES AT 60Hz
Fig. 3 Forward Surge Current Derating Curve

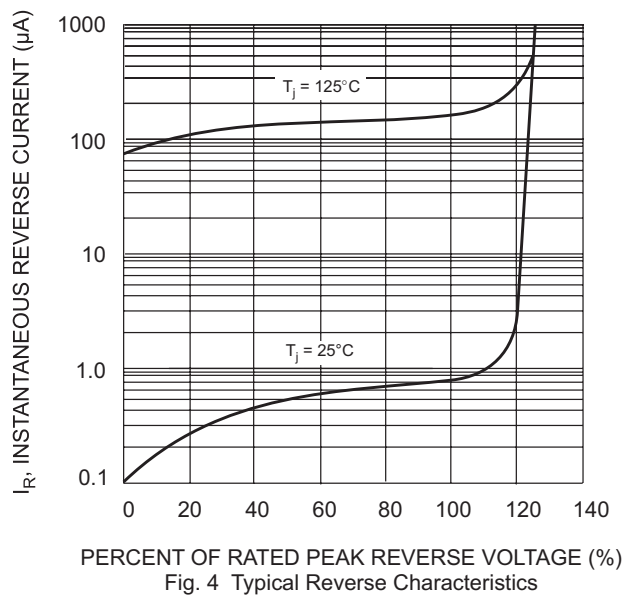

PERCENT OF RATED PEAK REVERSE VOLTAGE (%)
Fig. 4 Typical Reverse Characteristics

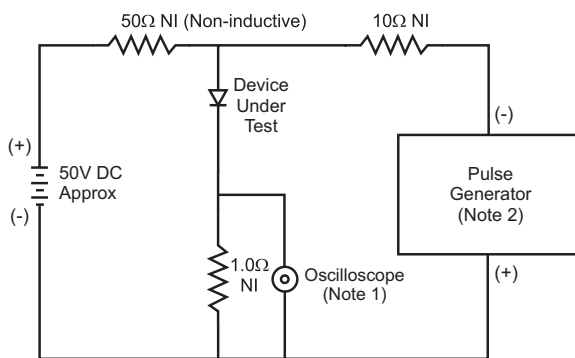

- Notes:
 1. Rise Time = 7.0ns max. Input Impedance = 1.0MΩ, 22pF.
 2. Rise Time = 10ns max. Input Impedance = 50Ω.

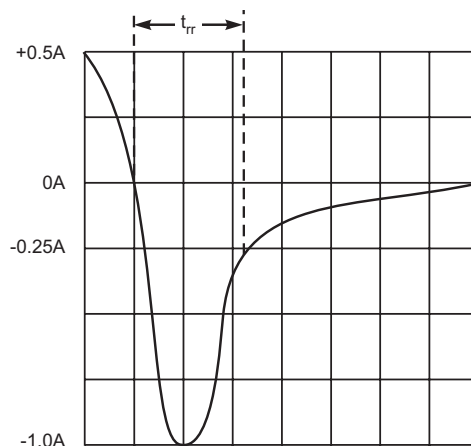

Set time base for 50/100 ns/cm

Fig. 5 Reverse Recovery Time Characteristic and Test Circuit