

**VOLTAGE RANGE: 50V-1000 V**  
**CURRENT: 3.0 A**

### Features

- Glass Passivated Die Construction
- Fast Recovery Time for High Efficiency
- Low Forward Voltage Drop and High Current Capability
- Ideally Suited for Automatic Assembly
- Plastic Material: UL Flammability

### Mechanical Data

- Case: SMC/DO-214AB, Molded Plastic
- Terminals: Solder Plated, Solderable per MIL-STD-750, Method 2026
- Polarity: Cathode Band or Cathode Notch
- Marking: Type Number
- Weight: 0.21 grams (approx.)

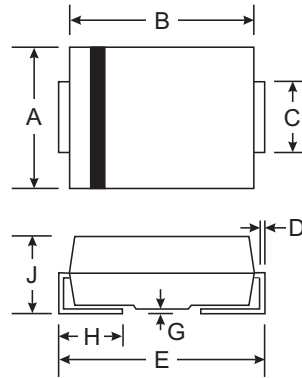

SMC/DO-214AB		
Dim	Min	Max
A	5.59	6.22
B	6.60	7.11
C	2.75	3.18
D	0.15	0.31
E	7.75	8.13
G	0.10	0.20
H	0.76	1.52
J	2.00	2.62
All Dimensions in mm		

### Maximum Ratings and Electrical Characteristics T<sub>A</sub> = 25°C unless otherwise specified

Single phase, half wave, 60Hz, resistive or inductive load. For capacitive load, derate current by 20%.

Characteristic	Symbol	RS3A	RS3B	RS3D	RS3G	RS3J	RS3K	RS3M	Unit
Peak Repetitive Reverse Voltage	V <sub>RRM</sub>								V
Working Peak Reverse Voltage	V <sub>RWM</sub>	50	100	200	400	600	800	1000	V
DC Blocking Voltage	V <sub>R</sub>								V
RMS Reverse Voltage	V <sub>R(RMS)</sub>	35	70	140	280	420	560	700	V
Average Rectified Output Current @ T <sub>T</sub> = 75°C	I <sub>O</sub>	3.0							A
Non-Repetitive Peak Forward Surge Current 8.3ms Single half sine-wave Superimposed on Rated Load (JEDEC Method)	I <sub>FSM</sub>	100							A
Forward Voltage @ I <sub>F</sub> = 3.0A	V <sub>FM</sub>	1.3							V
Peak Reverse Current @ T <sub>A</sub> = 25°C at Rated DC Blocking Voltage @ T <sub>A</sub> = 125°C	I <sub>RM</sub>	5.0 250							μA
Maximum Recovery Time (Note 3)	t <sub>rr</sub>	150				250	500		ns
Typical Junction Capacitance (Note 2)	C <sub>j</sub>	50							pF
Typical Thermal Resistance Junction to Terminal (Note 1)	R <sub>θJT</sub>	25							K/W
Operating and Storage Temperature Range	T <sub>j</sub> , T <sub>STG</sub>	-65 to +150							°C

- Notes:
1. Thermal resistance: junction to terminal, unit mounted on PC board with 5.0 mm<sup>2</sup> (0.013 mm thick) copper pad as heat sink.
  2. Measured at 1.0MHz and applied reverse voltage of 4.0V DC.
  3. Reverse recovery test conditions: I<sub>F</sub> = 0.5A, I<sub>R</sub> = 1.0A, I<sub>rr</sub> = 0.25A. See figure 5.

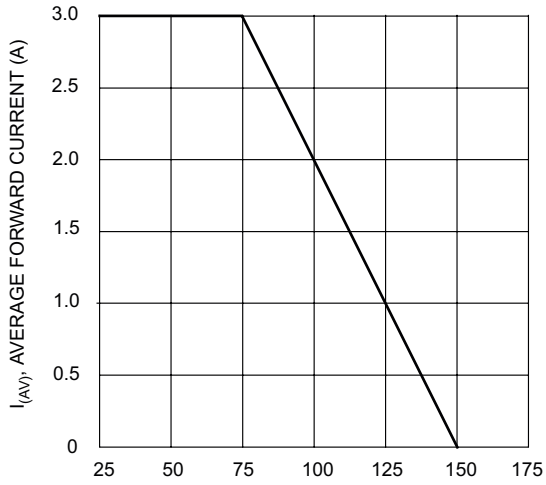

$T_T$ , TERMINAL TEMPERATURE (°C)  
Fig. 1 Forward Current Derating Curve

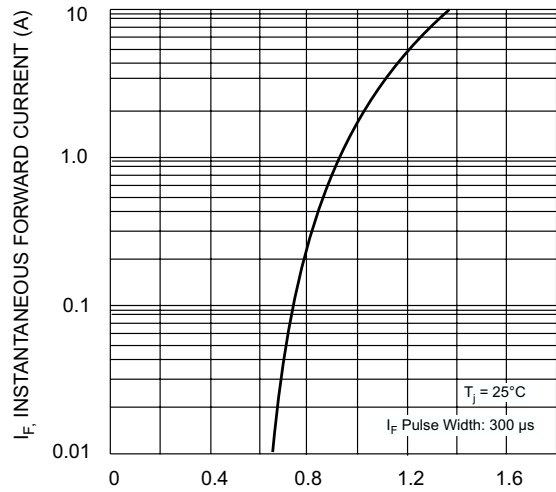

$V_F$ , INSTANTANEOUS FORWARD VOLTAGE (V)  
Fig. 2 Typical Forward Characteristics

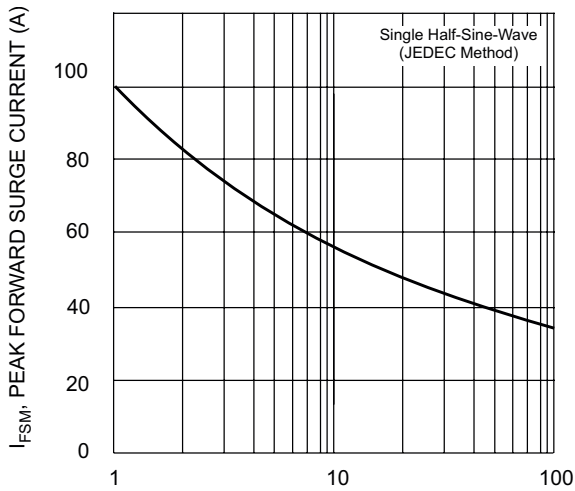

NUMBER OF CYCLES AT 60 Hz  
Fig. 3 Forward Surge Current Derating Curve

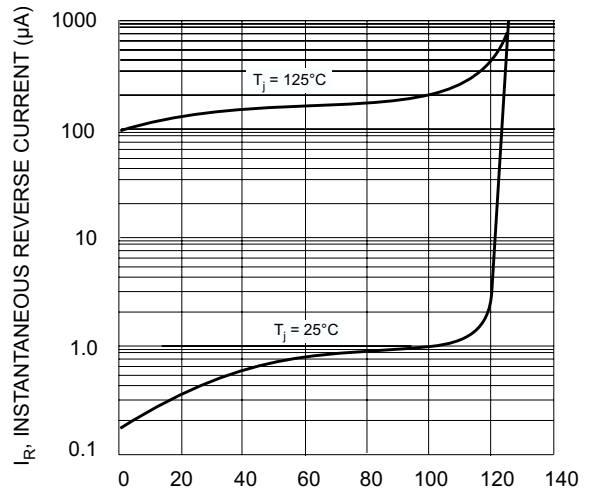

PERCENT OF RATED PEAK REVERSE VOLTAGE (%)  
Fig. 4 Typical Reverse Characteristics

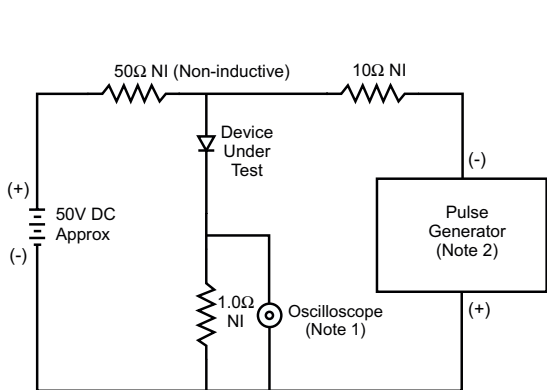

Notes:  
1. Rise Time = 7.0ns max. Input Impedance = 1.0MΩ, 22pF.  
2. Rise Time = 10ns max. Input Impedance = 50Ω.

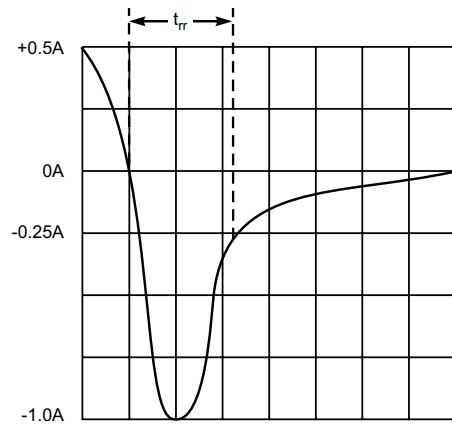

Set time base for 50/100 ns/cm

Fig. 5 Reverse Recovery Time Characteristic and Test Circuit