

VOLTAGE RANGE: 5.0 - 440 V
POWER: 400Watts

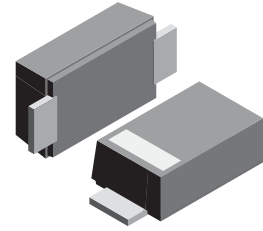

Features

- Glass Passivated Die Construction
- Uni- and Bi-Directional Versions Available
- Excellent Clamping Capability
- Fast Response Time
- Plastic Material: UL Flammability Classification Rating 94V-0

Mechanical Data

- Case: SMAF, Plastic
- Terminals: Solder plated, solderable per MIL-STD, Method 2026
- Marking: Date Code and Marking Code See Page 2
- Polarity : Color band denotes cathode end
- Weight: 0.0018 ounce, 0.064 grams

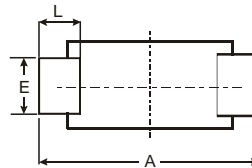
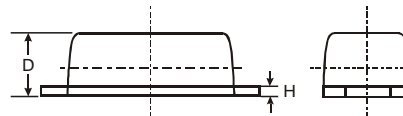
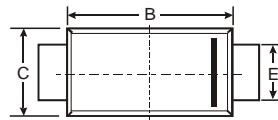

SMAF			
Dim	Min	Max	Typ
A	4.75	4.85	4.80
B	3.68	3.72	3.70
C	2.57	2.63	2.60
D	0.097	1.03	1.00
E	1.38	1.42	1.40
H	0.13	0.17	0.15
L	0.63	0.67	0.65
All Dimensions in mm			

Maximum Ratings @ T_A = 25°C unless otherwise specified

Characteristic	Symbol	Value	Unit
Peak Pulse Power Dissipation (Non repetitive current pulse derated above T _A = 25°C) (Note 1)	P _{PK}	400	W
Peak Forward Surge Current, 8.3ms Single Half Sine Wave Superimposed on Rated Load (JEDEC Method) (Notes 1, 2, & 3)	I _{FSM}	40	A
Instantaneous Forward Voltage @ I _{PP} = 35A (Notes 1, 2, & 3)	V _F	3.5	V
Operating and Storage Temperature Range	T _j , T _{STG}	-55 to +150	°C

- Notes:
1. Valid provided that terminals are kept at ambient temperature.
 2. Measured with 8.3ms single half sine-wave. Duty cycle = 4 pulses per minute maximum.
 3. Unidirectional units only.



TYPE		Marking		Reverse Stand-Off Voltage	Breakdown Voltage Min. @I _T	Breakdown Voltage Max. @ I _T	Test Current	Maximum Clamping Voltage @I _{PP}	Peak Pulse Current	Reverse Leakage @V _{RMW}
(Uni)	(Bi)	(Uni)	(Bi)	V _{RMW} (V)	V _{BR MIN} (V)	V _{BR MAX} (V)	I _T (mA)	V _C (V)	I _{PP} (A)	I _R (uA)
SMAF5.0	SMAF5.0C	HD	TD	5.0	6.40	7.55	10.0	9.6	41.7	800.0
SMAF5.0A	SMAF5.0CA	HE	TE	5.0	6.40	7.25	10.0	9.2	43.5	800.0
SMAF6.0	SMAF6.0C	HF	TF	6.0	6.67	8.45	10.0	11.4	35.1	800.0
SMAF6.0A	SMAF6.0CA	HG	TG	6.0	6.67	7.67	10.0	10.3	38.8	800.0
SMAF6.5	SMAF6.5C	HH	TH	6.5	7.22	9.14	10.0	12.3	32.5	500.0
SMAF6.5A	SMAF6.5CA	HK	TK	6.5	7.22	8.30	10.0	11.2	35.7	500.0
SMAF7.0	SMAF7.0C	HL	TL	7.0	7.78	9.86	10.0	13.3	30.1	200.0
SMAF7.0A	SMAF7.0CA	HM	TM	7.0	7.78	8.95	10.0	12.0	33.3	200.0
SMAF7.5	SMAF7.5C	HN	TN	7.5	8.33	10.67	1.0	14.3	28.0	100.0
SMAF7.5A	SMAF7.5CA	HP	TP	7.5	8.33	9.58	1.0	12.9	31.0	100.0
SMAF8.0	SMAF8.0C	HQ	TQ	8.0	8.89	11.3	1.0	15.0	26.7	50.0
SMAF8.0A	SMAF8.0CA	HR	TR	8.0	8.89	10.23	1.0	13.6	29.4	50.0
SMAF8.5	SMAF8.5C	HS	TS	8.5	9.44	11.92	1.0	15.9	25.2	20.0
SMAF8.5A	SMAF8.5CA	HT	TT	8.5	9.44	10.82	1.0	14.4	27.8	20.0
SMAF9.0	SMAF9.0C	HU	TU	9.0	10.0	12.6	1.0	16.9	23.7	10.0
SMAF9.0A	SMAF9.0CA	HV	TV	9.0	10.0	11.5	1.0	15.4	26.0	10.0
SMAF10	SMAF10C	HW	TW	10	11.1	14.1	1.0	18.8	21.3	5.0
SMAF10A	SMAF10CA	HX	TX	10	11.1	12.8	1.0	17.0	23.5	5.0
SMAF11	SMAF11C	HY	TY	11	12.2	15.4	1.0	20.1	19.9	5.0
SMAF11A	SMAF11CA	HZ	TZ	11	12.2	14.0	1.0	18.2	22.0	5.0
SMAF12	SMAF12C	ID	UD	12	13.3	16.9	1.0	22.0	18.2	5.0
SMAF12A	SMAF12CA	IE	UE	12	13.3	15.3	1.0	19.9	20.1	5.0
SMAF13	SMAF13C	IF	UF	13	14.4	18.2	1.0	23.8	16.8	5.0
SMAF13A	SMAF13CA	IG	UG	13	14.4	16.5	1.0	21.5	18.6	5.0
SMAF14	SMAF14C	IH	UH	14	15.6	19.8	1.0	25.8	15.5	5.0
SMAF14A	SMAF14CA	IK	UK	14	15.6	17.9	1.0	23.2	17.2	5.0
SMAF15	SMAF15C	IL	UL	15	16.7	21.1	1.0	26.9	14.9	5.0
SMAF15A	SMAF15CA	IM	UM	15	16.7	19.2	1.0	24.4	16.4	5.0
SMAF16	SMAF16C	IN	UN	16	17.8	22.6	1.0	28.8	13.9	5.0
SMAF16A	SMAF16CA	IP	UP	16	17.8	20.5	1.0	26.0	15.4	5.0
SMAF17	SMAF17C	IQ	UQ	17	18.9	23.9	1.0	30.5	13.1	5.0
SMAF17A	SMAF17CA	IR	UR	17	18.9	21.7	1.0	27.6	14.5	5.0
SMAF18	SMAF18C	IS	US	18	20.0	25.3	1.0	32.2	12.4	5.0
SMAF18A	SMAF18CA	IT	UT	18	20.0	23.3	1.0	29.2	13.7	5.0
SMAF20	SMAF20C	IU	UU	20	22.2	28.1	1.0	35.8	11.2	5.0
SMAF20A	SMAF20CA	IV	UV	20	22.2	25.5	1.0	32.4	12.3	5.0
SMAF22	SMAF22C	IW	UW	22	24.4	30.9	1.0	39.4	10.2	5.0
SMAF22A	SMAF22CA	IX	UX	22	24.4	28.0	1.0	35.5	11.3	5.0
SMAF24	SMAF24C	IY	UY	24	26.7	33.8	1.0	43.0	9.3	5.0



TYPE		Marking		Reverse Stand-Off Voltage	Breakdown Voltage Min. @I _T	Breakdown Voltage Max. @ I _T	Test Current	Maximum Clamping Voltage @I _{PP}	Peak Pulse Current	Reverse Leakage @V _{RWM}
(Uni)	(Bi)	(Uni)	(Bi)	V _{RWM} (V)	V _{BR MIN} (V)	V _{BR MAX} (V)	I _T (mA)	V _C (V)	I _{PP} (A)	I _R (uA)
SMAF24A	SMAF24CA	IZ	UZ	24	26.7	30.7	1.0	38.9	10.3	5.0
SMAF26	SMAF26C	JD	VD	26	28.9	36.6	1.0	46.6	8.6	5.0
SMAF26A	SMAF26CA	JE	VE	26	28.9	33.2	1.0	42.1	9.5	5.0
SMAF28	SMAF28C	JF	VF	28	31.1	39.4	1.0	50.0	8.0	5.0
SMAF28A	SMAF28CA	JG	VG	28	31.1	35.8	1.0	45.4	8.8	5.0
SMAF30	SMAF30C	JH	VH	30	33.3	42.2	1.0	53.5	7.5	5.0
SMAF30A	SMAF30CA	JK	VK	30	33.3	38.3	1.0	48.4	8.3	5.0
SMAF33	SMAF33C	JL	VL	33	36.7	46.5	1.0	59.0	6.8	5.0
SMAF33A	SMAF33CA	JM	VM	33	36.7	42.2	1.0	53.3	7.5	5.0
SMAF36	SMAF36C	JN	VN	36	40.0	50.7	1.0	64.3	6.2	5.0
SMAF36A	SMAF36CA	JP	VP	36	40.0	46.0	1.0	58.1	6.9	5.0
SMAF40	SMAF40C	JQ	VQ	40	44.4	56.3	1.0	71.4	5.6	5.0
SMAF40A	SMAF40CA	JR	VR	40	44.4	51.1	1.0	64.5	6.2	5.0
SMAF43	SMAF43C	JS	VS	43	47.7	60.5	1.0	76.7	5.2	5.0
SMAF43A	SMAF43CA	JT	VT	43	47.8	54.9	1.0	69.4	5.8	5.0
SMAF45	SMAF45C	JU	VU	45	50.0	63.3	1.0	80.3	5.0	5.0
SMAF45A	SMAF45CA	JV	VV	45	50.0	57.5	1.0	72.7	5.5	5.0
SMAF48	SMAF48C	JW	VW	48	53.3	67.5	1.0	85.5	4.7	5.0
SMAF48A	SMAF48CA	JX	VX	48	53.3	61.3	1.0	77.4	5.2	5.0
SMAF51	SMAF51C	JY	VY	51	56.7	71.8	1.0	91.1	4.4	5.0
SMAF51A	SMAF51CA	JZ	VZ	51	56.7	65.2	1.0	82.4	4.9	5.0
SMAF54	SMAF54C	RD	WD	54	60.0	76.0	1.0	96.3	4.2	5.0
SMAF54A	SMAF54CA	RE	WE	54	60.0	69.0	1.0	87.1	4.6	5.0
SMAF58	SMAF58C	RF	WF	58	64.4	81.6	1.0	103	3.9	5.0
SMAF58A	SMAF58CA	RG	WG	58	64.4	74.1	1.0	93.6	4.3	5.0
SMAF60	SMAF60C	RH	WH	60	66.7	84.5	1.0	107	3.7	5.0
SMAF60A	SMAF60CA	RK	WK	60	66.7	76.7	1.0	96.8	4.1	5.0
SMAF64	SMAF64C	RL	WL	64	71.1	90.1	1.0	114	3.5	5.0
SMAF64A	SMAF64CA	RM	WM	64	71.1	81.8	1.0	103	3.9	5.0
SMAF70	SMAF70C	RN	WN	70	77.8	98.6	1.0	125	3.2	5.0
SMAF70A	SMAF70CA	RP	WP	70	77.8	89.5	1.0	113	3.5	5.0
SMAF75	SMAF75C	RQ	WQ	75	83.0	105.7	1.0	134	3.0	5.0
SMAF75A	SMAF75CA	RR	WR	75	83.0	95.8	1.0	121	3.3	5.0
SMAF78	SMAF78C	RS	WS	78	86.0	109.8	1.0	139	2.9	5.0
SMAF78A	SMAF78CA	RT	WT	78	86.0	99.7	1.0	126	3.2	5.0
SMAF85	SMAF85C	RU	WU	85	94.0	119.2	1.0	151	2.6	5.0
SMAF85A	SMAF85CA	RV	WV	85	94.0	108.2	1.0	137	2.9	5.0

TYPE		Marking		Reverse Stand-Off Voltage	Breakdown Voltage Min. @I _T	Breakdown Voltage Max. @ I _T	Test Current	Maximum Clamping Voltage @I _{PP}	Peak Pulse Current	Reverse Leakage @V _{RWM}
(Uni)	(Bi)	(Uni)	(Bi)	V _{RWM} (V)	V _{BR MIN} (V)	V _{BR MAX} (V)	I _T (mA)	V _C (V)	I _{PP} (A)	I _R (uA)
SMAF90	SMAF90C	RW	WW	90	100	126.5	1.0	160	2.5	5.0
SMAF90A	SMAF90CA	RX	WX	90	100	115.5	1.0	146	2.7	5.0
SMAF100	SMAF100C	RY	WY	100	111	141.0	1.0	179	2.2	5.0
SMAF100A	SMAF100CA	RZ	WZ	100	111	128.0	1.0	162	2.5	5.0
SMAF110	SMAF110C	SD	XD	110	122	154.5	1.0	196	2.0	5.0
SMAF110A	SMAF110CA	SE	XE	110	122	140.5	1.0	177	2.3	5.0
SMAF120	SMAF120C	SF	XF	120	133	169.0	1.0	214	1.9	5.0
SMAF120A	SMAF120CA	SG	XG	120	133	153.0	1.0	193	2.1	5.0
SMAF130	SMAF130C	SH	XH	130	144	182.5	1.0	231	1.7	5.0
SMAF130A	SMAF130CA	SK	XK	130	144	165.5	1.0	209	1.9	5.0
SMAF150	SMAF150C	SL	XL	150	167	211.5	1.0	268	1.5	5.0
SMAF150A	SMAF150CA	SM	XM	150	167	192.5	1.0	243	1.6	5.0
SMAF160	SMAF160C	SN	XN	160	178	226.0	1.0	287	1.4	5.0
SMAF160A	SMAF160CA	SP	XP	160	178	205.0	1.0	259	1.5	5.0
SMAF170	SMAF170C	SQ	XQ	170	189	239.5	1.0	304	1.3	5.0
SMAF170A	SMAF170CA	SR	XR	170	189	217.5	1.0	275	1.5	5.0
SMAF180	SMAF180C	SS	XS	180	200	253.8	1.0	321	1.2	5.0
SMAF180A	SMAF180CA	ST	XT	180	200	230.4	1.0	290	1.4	5.0
SMAF190	SMAF190C	SU	XU	190	211	267.9	1.0	339	1.2	5.0
SMAF190A	SMAF190CA	SV	XV	190	211	243.2	1.0	306	1.3	5.0
SMAF200	SMAF200C	SW	XW	200	222	282.0	1.0	356	1.1	5.0
SMAF200A	SMAF200CA	SX	XX	200	222	256.0	1.0	322	1.2	5.0
SMAF210	SMAF210C	SY	XY	210	233	296.1	1.0	375	1.1	5.0
SMAF210A	SMAF210CA	SZ	XZ	210	233	268.8	1.0	339	1.2	5.0
SMAF220	SMAF220C	ZD	YD	220	244	310.2	1.0	392	1.0	5.0
SMAF220A	SMAF220CA	ZE	YE	220	244	281.6	1.0	355	1.1	5.0
SMAF250	SMAF250C	ZF	YF	250	278	342.5	1.0	447	0.9	5.0
SMAF250A	SMAF250CA	ZG	YG	250	278	309.0	1.0	403	1.0	5.0
SMAF300	SMAF300C	ZH	YH	300	333	411.0	1.0	535	0.7	5.0
SMAF300A	SMAF300CA	ZK	YK	300	333	371.0	1.0	484	0.8	5.0
SMAF350	SMAF350C	ZL	YL	350	389	479.5	1.0	624	0.6	5.0
SMAF350A	SMAF350CA	ZM	YM	350	389	432.0	1.0	565	0.7	5.0
SMAF400	SMAF400C	ZN	YN	400	444	548.0	1.0	687	0.6	5.0
SMAF400A	SMAF400CA	ZP	YP	400	444	494.0	1.0	645	0.6	5.0
SMAF440	SMAF440C	ZQ	YQ	440	489	602.8	1.0	786	0.5	5.0
SMAF440A	SMAF440CA	ZR	YR	440	489	543.0	1.0	710	0.6	5.0

Ratings and Characteristic Curves $T_A=25^\circ\text{C}$ unless otherwise noted

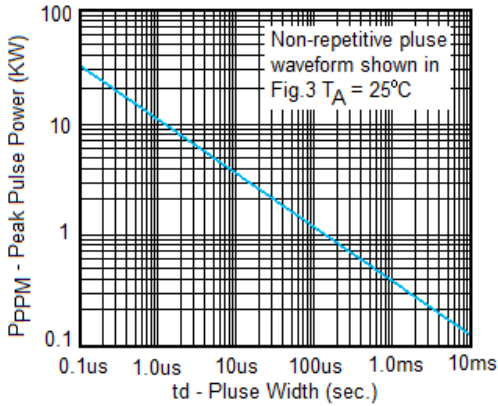

Fig. 1 Peak Pulse Power Rating

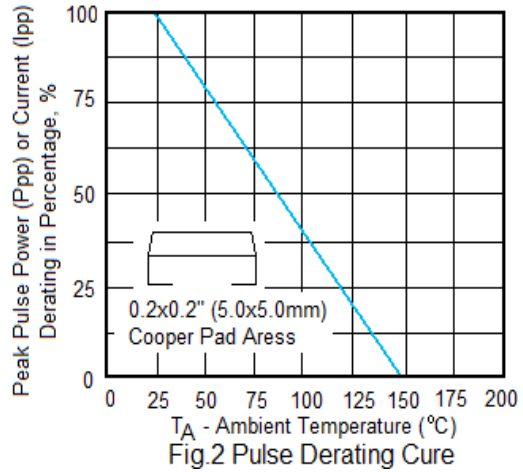

Fig. 2 Pulse Derating Curve

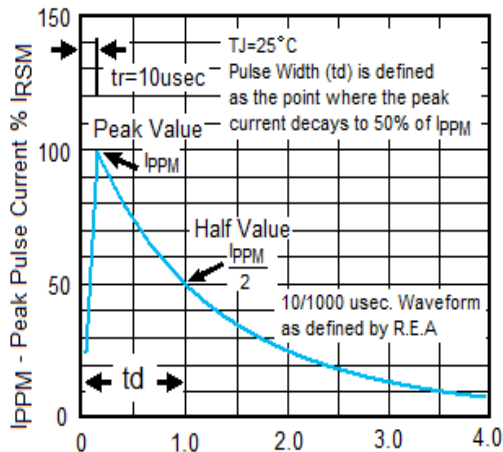

Fig. 3 Pulse Waveform

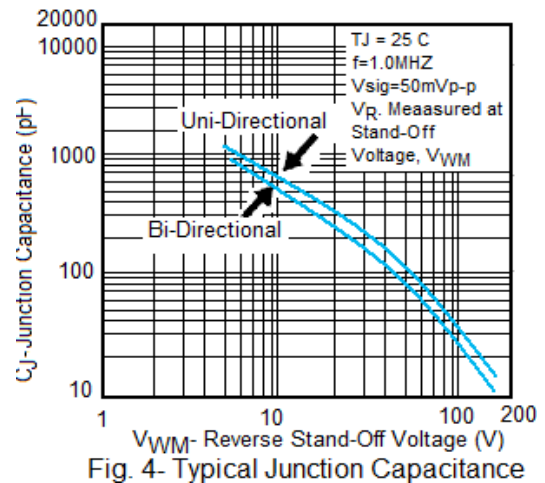

Fig. 4- Typical Junction Capacitance