

VOLTAGE RANGE: 50 - 1000V
CURRENT: 1.0A

Features

- Glass passivated device
- Ideal for surface mounted applications
- Low reverse leakage
- Metallurgically bonded construction
- High temperature soldering guaranteed:
 ● 250°C/10 seconds, 0.375" (9.5mm) lead length,
 5 lbs. (2.3kg) tension

Mechanical Data

- Case: JEDEC SOD-123FL molded plastic body over passivated junction
- Terminals : Plated axial leads, solderable per MIL-STD-750, Method 2026
- Polarity : Color band denotes cathode end
- Mounting Position : Any
- Weight: 0.0007 ounce, 0.02 grams

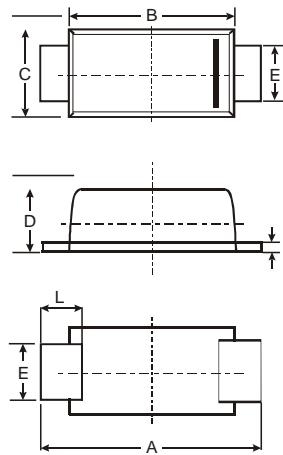
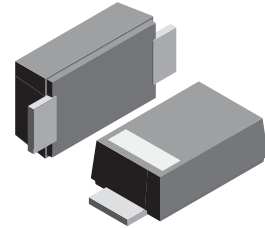

SOD-123FL			
Dim	Min	Max	Typ
A	3.50	3.80	3.65
B	2.60	2.90	2.75
C	1.70	1.90	1.80
D	0.09	1.10	1.00
E	0.08	1.10	0.095
H	0.12	0.20	0.16
L	0.07	0.09	0.08
All Dimensions in mm			

Maximum Ratings and Electrical Characteristics $T_A = 25^\circ\text{C}$ unless otherwise specified

Single phase, half wave, 60Hz, resistive or inductive load. For capacitive load, derate current by 20%.

Characteristic	Symbol	SOD1F1	SOD1F2	SOD1F3	SOD1F4	SOD1F5	SOD1F6	SOD1F7	Unit
Maximum repetitive peak reverse voltage	V_{RRM}	50	100	200	400	600	800	1000	V
Maximum RMS voltage	V_{RMS}	35	70	140	280	420	560	700	V
Maximum DC blocking voltage	V_{DC}	50	100	200	400	600	800	1000	V
Maximum average forward rectified current at $T_A=65^\circ\text{C}$ (NOTE 1)	$I_{(AV)}$	1.0							A
Peak forward surge current 8.3ms single half sine-wave superimposed on rated load (JEDEC Method) $T_L=25^\circ\text{C}$	I_{FSM}	30.0							A
Maximum instantaneous forward voltage at 1.0A	V_F	1.3							V
Maximum DC reverse current $T_A=25^\circ\text{C}$ at rated DC blocking voltage $T_A=100^\circ\text{C}$	I_R	5.0 100.0							μA
Maximum reverse recovery time (NOTE 2)	t_{rr}	150			250		500		ns
Typical junction capacitance (NOTE 3)	C_J	15							pF
Typical thermal resistance (NOTE 4)	$R_{\theta JA}$	180							K/W
Operating junction and storage temperature range	T_J, T_{STG}	-50 to +150							$^\circ\text{C}$

- Note:**
1. Averaged over any 20ms period.
 2. Measured with $I_F=0.5\text{A}$, $I_R=1\text{A}$, $I_{rr}=0.25\text{A}$.
 3. Measured at 1MHz and applied reverse voltage of 4.0V D.C.
 4. Thermal resistance junction to ambient, 6.0 mm² copper pads to each terminal.

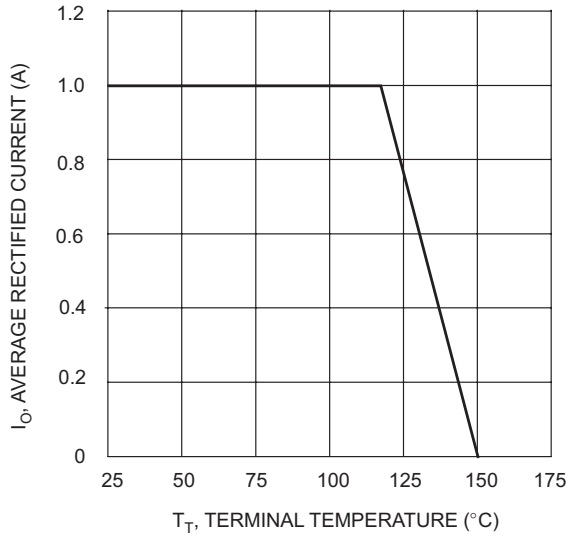

Fig. 1 Forward Current Derating Curve

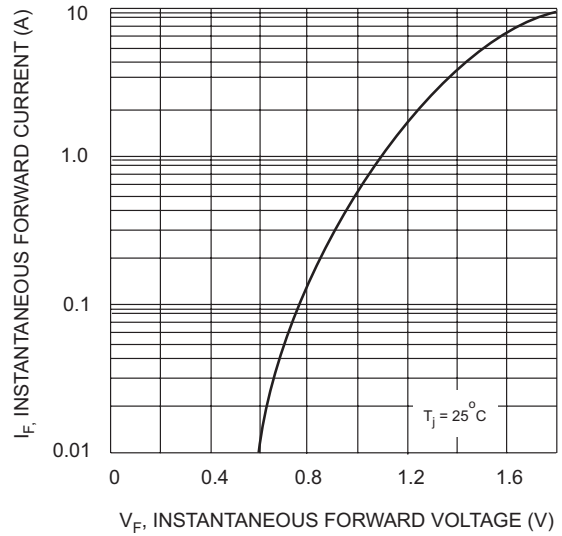

Fig. 2 Typical Forward Characteristics

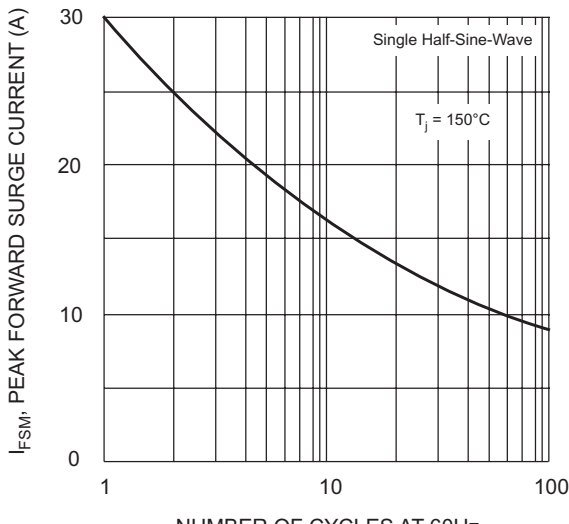

Fig. 3 Forward Surge Current Derating Curve

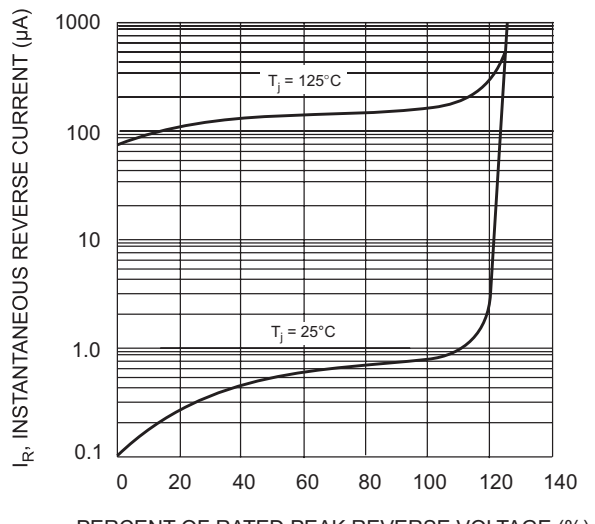
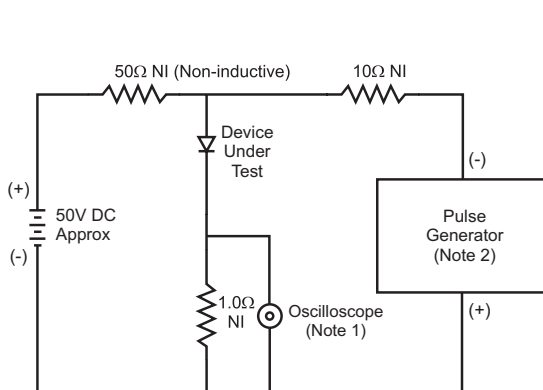

Fig. 4 Typical Reverse Characteristics



Notes:
 1. Rise Time = 7.0ns max. Input Impedance = 1.0MΩ, 22pF.
 2. Rise Time = 10ns max. Input Impedance = 50Ω.

Set time base for 50/100 ns/cm

Fig. 5 Reverse Recovery Time Characteristic and Test Circuit