

VOLTAGE RANGE: 2.0 - 56V
POWER: 0.2Watts

Features

- Ultra-Small Surface Mount Package
- Ideally suited for Automated Assembly Processes
- Very Sharp Breakdown Characteristics
- Very Tight Tolerance on Zener Breakdown Voltage

Mechanical Data

- Case: SOD-323, Molded Plastic
- Terminals: Plated Leads Solderable per MIL-STD-202, Method 208
- Polarity: Cathode Band
- Weight: 0.004 grams (approx.)
- Marking: A3

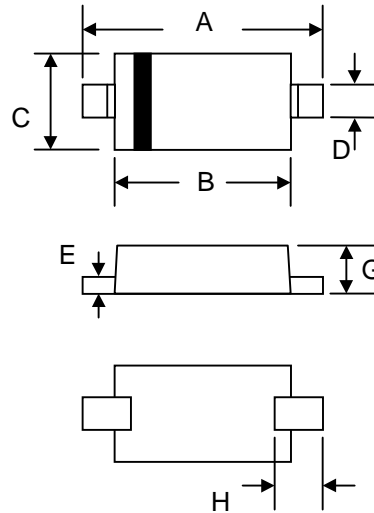
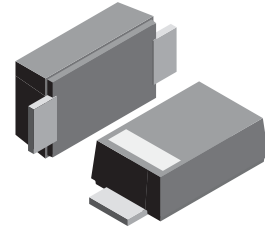

SOD-323		
Dim	Min	Max
A	2.30	2.70
B	1.75	1.95
C	1.15	1.35
D	0.25	0.35
E	0.05	0.15
G	0.70	0.95
H	0.30	—

All Dimensions in mm

Maximum Ratings $T_A = 25^\circ\text{C}$ unless otherwise specified

Characteristic	Symbol	Value	Unit
Power Dissipation	P_d	200	mW
Thermal Resistance, Junction to Ambient Air	$R_{\theta JA}$	625	$^\circ\text{C}/\text{W}$
Operating and Storage Temperature Range	T_j, T_{STG}	-65 to +150	$^\circ\text{C}$



Electrical Characteristics @ T_A = 25°C unless otherwise specified

Type Number	Zener Voltage Range (Note 3)			Maximum Zener Impedance (Note 4)			Maximum Reverse Current (Note 3)	
	V _{ZT} @ I _{ZT}		I _{ZT}	Z _{ZT} @ I _{ZT}	Z _{ZK} @ I _{ZK}	I _{ZK}	I _R	V _R
	Min (V)	Max (V)	mA	Ω		mA	μA	V
UDZ2V0B	2.020	2.200	5	100	1000	0.5	120	0.5
UDZ2V2B	2.220	2.410	5	100	1000	0.5	120	0.7
UDZ2V4B	2.430	2.630	5	100	1000	0.5	120	1.0
UDZ2V7B	2.690	2.910	5	110	1000	0.5	100	1.0
UDZ3V0B	3.010	3.220	5	120	1000	0.5	50	1.0
UDZ3V3B	3.320	3.530	5	120	1000	0.5	20	1.0
UDZ3V6B	3.600	3.845	5	100	1000	1.0	10	1.0
UDZ3V9B	3.890	4.160	5	100	1000	1.0	5	1.0
UDZ4V3B	4.170	4.430	5	100	1000	1.0	5	1.0
UDZ4V7B	4.550	4.750	5	100	800	0.5	2	1.0
UDZ5V1B	4.980	5.200	5	80	500	0.5	2	1.5
UDZ5V6B	5.490	5.730	5	60	200	0.5	1	2.5
UDZ6V2B	6.060	6.330	5	60	100	0.5	1	3.0
UDZ6V8B	6.650	6.930	5	40	60	0.5	0.5	3.5
UDZ7V5B	7.280	7.600	5	30	60	0.5	0.5	4.0
UDZ8V2B	8.020	8.360	5	30	60	0.5	0.5	5.0
UDZ9V1B	8.850	9.230	5	30	60	0.5	0.5	6.0
UDZ10B	9.770	10.210	5	30	60	0.5	0.1	7.0
UDZ11B	10.760	11.220	5	30	60	0.5	0.1	8.0
UDZ12B	11.740	12.240	5	30	80	0.5	0.1	9.0
UDZ13B	12.910	13.490	5	37	80	0.5	0.1	10.0
UDZ15B	14.340	14.980	5	42	80	0.5	0.1	11.0
UDZ16B	15.850	16.510	5	50	80	0.5	0.1	12.0
UDZ18B	17.560	18.350	5	65	80	0.5	0.1	13.0
UDZ20B	19.520	20.390	5	85	100	0.5	0.1	15.0
UDZ22B	21.540	22.470	5	100	100	0.5	0.1	17.0
UDZ24B	23.720	24.780	5	120	120	0.5	0.1	19.0
UDZ27B	26.190	27.530	5	150	150	0.5	0.1	21.0
UDZ30B	29.190	30.690	5	200	200	0.5	0.1	23.0
UDZ33B	32.150	33.790	5	250	250	0.5	0.1	25.0
UDZ36B	35.070	36.870	5	300	300	0.5	0.1	27.0
UDZ39B	38.025	39.975	5	300	350	0.5	0.1	29.0
UDZ43B	41.925	44.075	2	300	400	0.5	0.1	32.0
UDZ47B	45.825	48.175	2	300	450	0.5	0.1	35.0
UDZ51B	49.725	52.275	2	350	500	0.5	0.1	38.0
UDZ56B	54.600	57.400	2	350	500	0.5	0.1	42.0

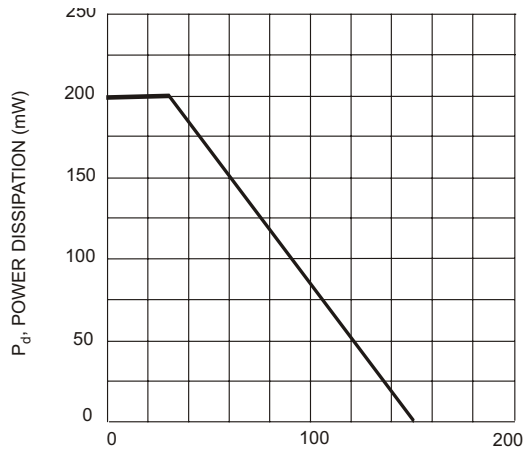

T_A , AMBIENT TEMPERATURE, ($^{\circ}C$)
Fig. 1 Power Derating Curve

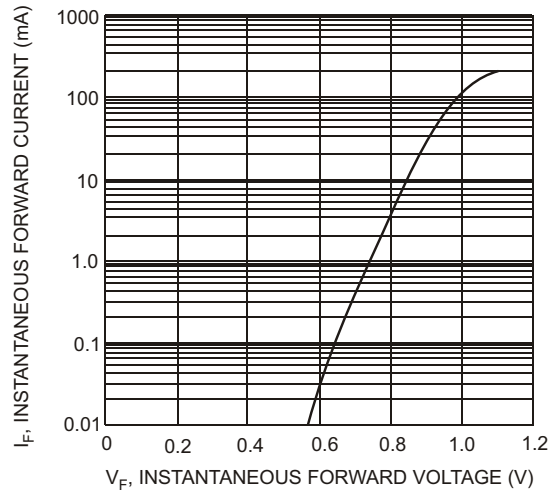

V_F , INSTANTANEOUS FORWARD VOLTAGE (V)
Fig. 2 Typical Forward Characteristics

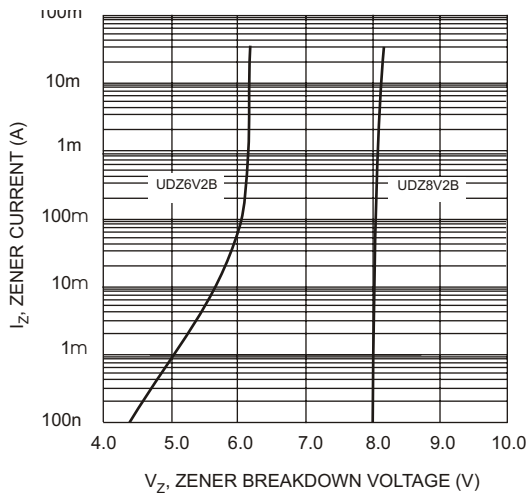

V_Z , ZENER BREAKDOWN VOLTAGE (V)
Fig. 3 Typical Reverse Characteristics, UDZ6V2B - UDZ8V2B

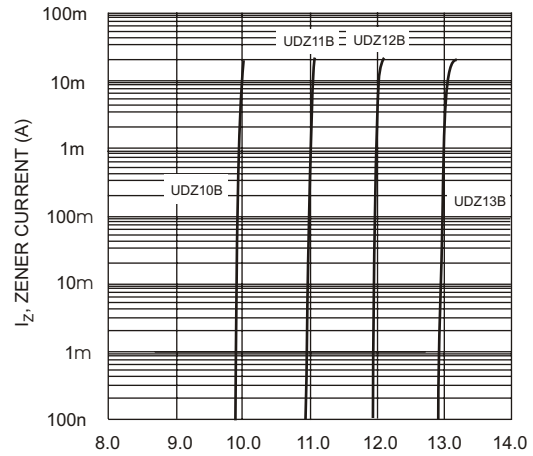

V_Z , ZENER BREAKDOWN VOLTAGE (V)
Fig. 4 Typical Reverse Characteristics, UDZ10B - UDZ13B

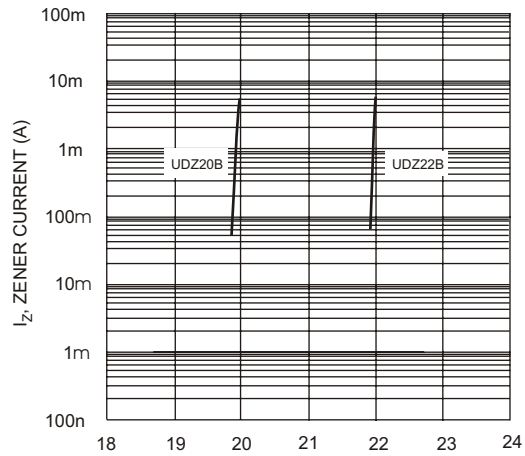

V_Z , ZENER BREAKDOWN VOLTAGE (V)
Fig. 5 Typical Reverse Characteristics, UDZ20B - UDZ22B

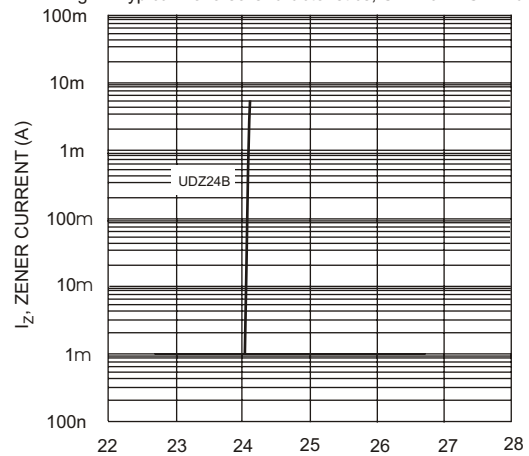

V_Z , ZENER BREAKDOWN VOLTAGE (V)
Fig. 6 Typical Reverse Characteristics, UDZ24B

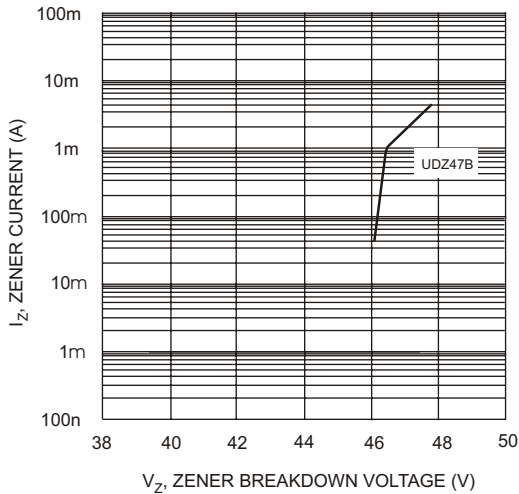

Fig. 7 Typical Reverse Characteristics, UDZ47B

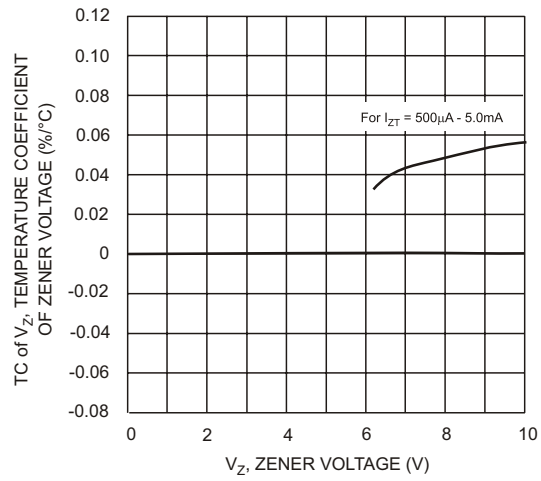

Fig. 8 Typical Temperature Coefficient of Zener Voltage vs. Zener Voltage, UDZ6V2B-UDZ10B

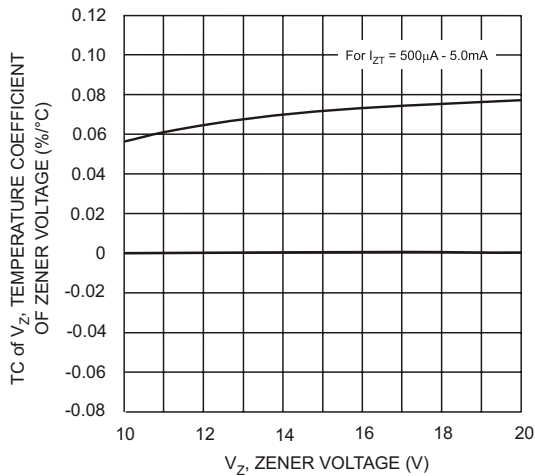

Fig. 9 Typical Temperature Coefficient of Zener Voltage vs. Zener Voltage, UDZ10B-UDZ20B

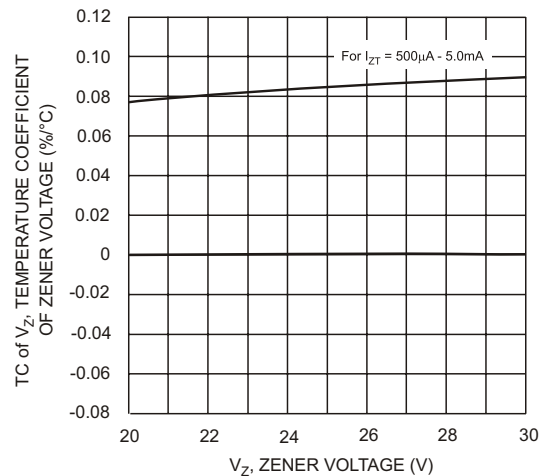

Fig. 10 Typical Temperature Coefficient of Zener Voltage, UDZ20B-UDZ30B

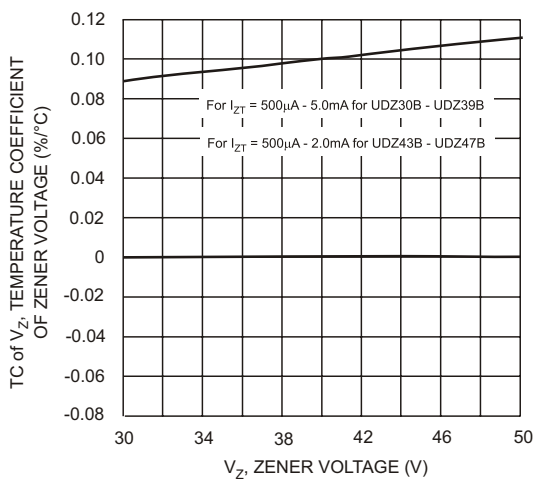

Fig. 11 Typical Temperature Coefficient of Zener Voltage, UDZ30B-UDZ47B