

VOLTAGE RANGE: 50 - 600V

CURRENT: 2.0 A

Features

- Diffused Junction
- Low Forward Voltage Drop
- High Current Capability
- High Reliability
- High Surge Current Capability

Mechanical Data

- Case : DO-15, Molded plastic
- Epoxy : UL94V-O rate flame retardant
- Lead : Axial lead solderable per MIL-STD-202, Method 208 guaranteed
- Polarity : Color band denotes cathode end
- Mounting position : Any
- Weight : 0.465 gram

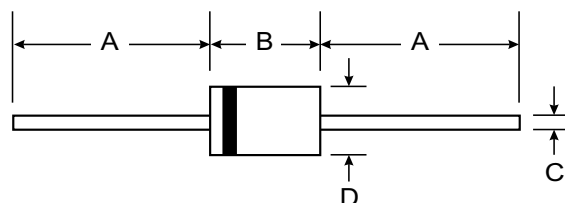
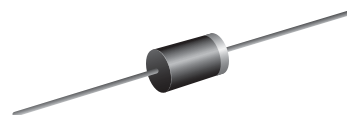

DO-15		
Dim	Min	Max
A	25.40	—
B	5.50	7.62
C	0.686	0.889
D	2.60	3.60
All Dimensions in mm		

Maximum Ratings and Electrical Characteristics $T_A = 25^\circ\text{C}$ unless otherwise specified

Single phase, half wave, 60Hz, resistive or inductive load. For capacitive load, derate current by 20%.

Characteristic	Symbol	MUR205	MUR210	MUR215	MUR220	MUR230	MUR240	MUR260	Unit
Peak Repetitive Reverse Voltage	V_{RRM}	50	100	150	200	300	400	600	V
Working Peak Reverse Voltage	V_{RWM}								
DC Blocking Voltage	V_R								
RMS Reverse Voltage	$V_{R(RMS)}$	35	70	105	140	210	280	420	V
Average Rectified Output Current (Note 1) $@T_A = 55^\circ\text{C}$	I_O	2.0							A
Non-Repetitive Peak Forward Surge Current 8.3ms Single half sine-wave superimposed on rated load (JEDEC Method)	I_{FSM}	50							A
Forward Voltage $@I_F = 2.0\text{A}$	V_{FM}	0.95				1.3		1.7	V
Peak Reverse Current $@T_A = 25^\circ\text{C}$ At Rated DC Blocking Voltage $@T_A = 100^\circ\text{C}$	I_{RM}	5.0				100			μA
Reverse Recovery Time (Note 2)	t_{rr}	35							nS
Typical Junction Capacitance (Note 3)	C_j	60				30			pF
Operating Temperature Range	T_j	-65 to +125							$^\circ\text{C}$
Storage Temperature Range	T_{STG}	-65 to +150							$^\circ\text{C}$

Note: 1. Leads maintained at ambient temperature at a distance of 9.5mm from the case

2. Measured with $I_F = 0.5\text{A}$, $I_R = 1.0\text{A}$, $I_{RR} = 0.25\text{A}$. See figure 5.

3. Measured at 1.0 MHz and applied reverse voltage of 4.0V D.C.

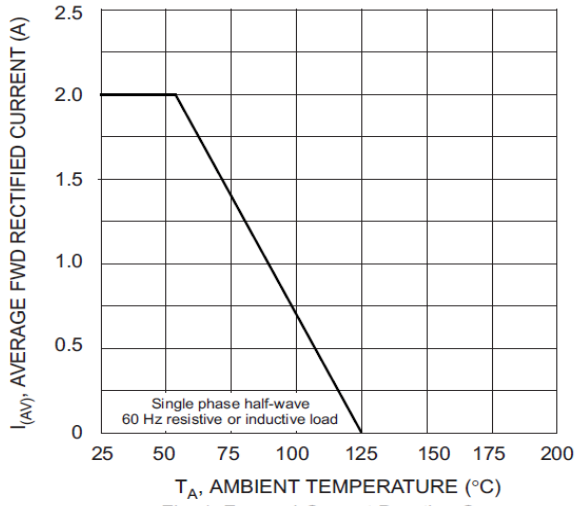

Fig. 1 Forward Current Derating Curve

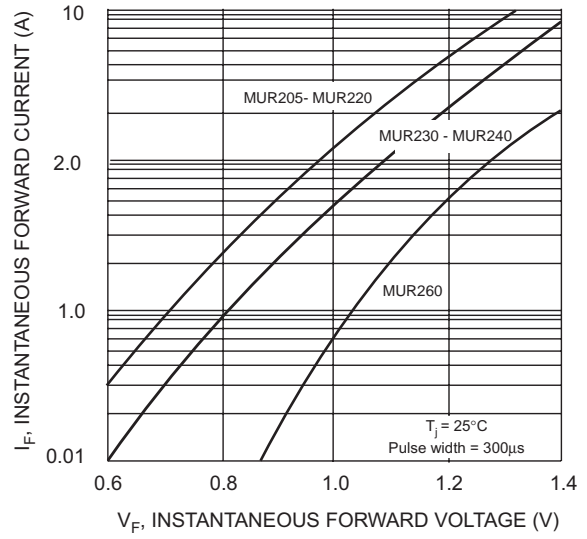

Fig. 2 Typical Forward Characteristics

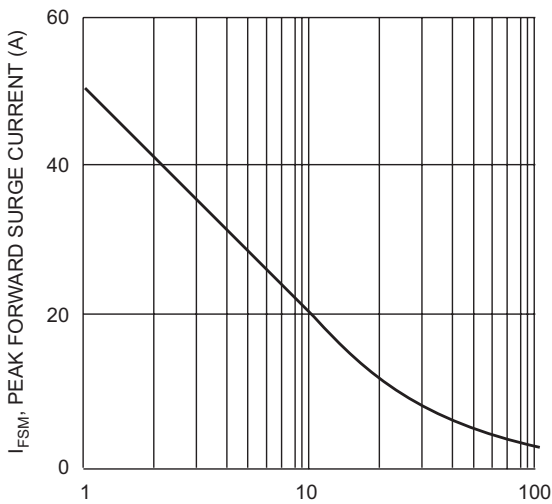

Fig. 3 Peak Forward Surge Current

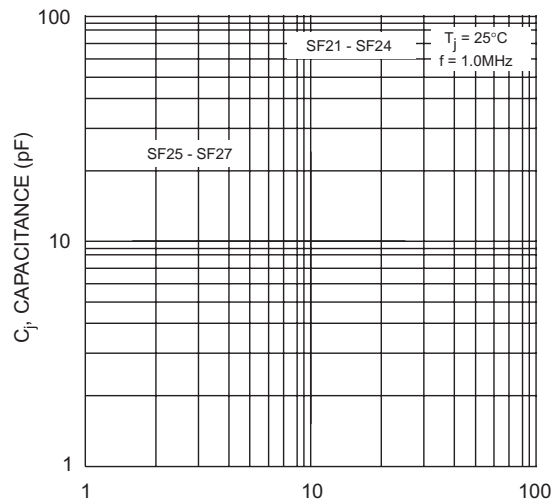
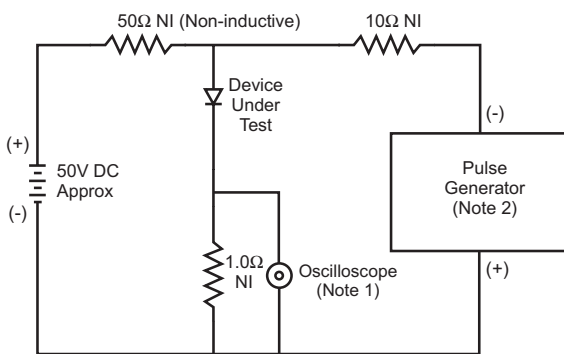
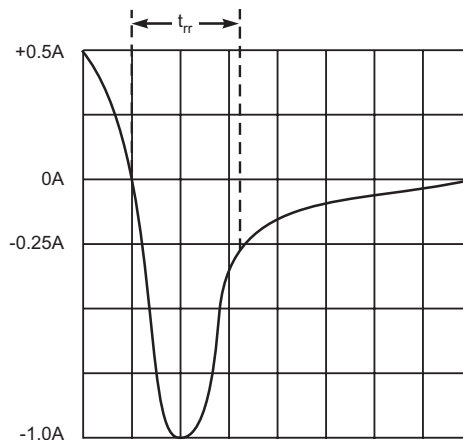

Fig. 4 Typical Junction Capacitance



- Notes:
 1. Rise Time = 7.0ns max. Input Impedance = 1.0M Ω , 22pF.
 2. Rise Time = 10ns max. Input Impedance = 50 Ω .



Set time base for 5/10ns/cm

Fig. 5 Reverse Recovery Time Characteristic and Test Circuit