

**Description**

The 1.5KE series is designed specifically to protect sensitive electronic equipment from voltage transients induced by lightning and other transient voltage events.

**Features**

- I Fast response time
- I Matte tin lead-free Plated
- I Low incremental surge resistance
- I Halogen free and RoHS compliant
- I Typical  $I_R$  less than  $1\mu A$  above 12V
- I Compatible with industrial standard package DO-201
- I For surface mounted applications to optimize board space
- I 1500W peak pulse power capability with at 10/1000 $\mu s$  waveform, repetition rate (duty cycle): 0.01%
- I High temperature soldering guaranteed: 260°C/ 10 seconds

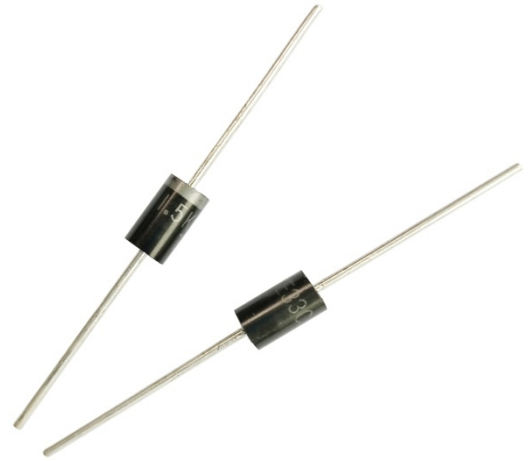

**Electrical symbol**

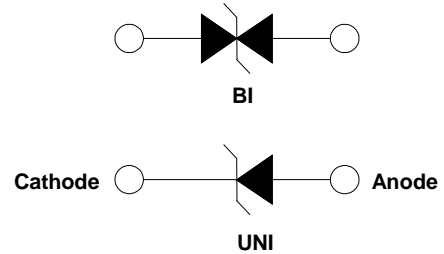

**Part Number Code**

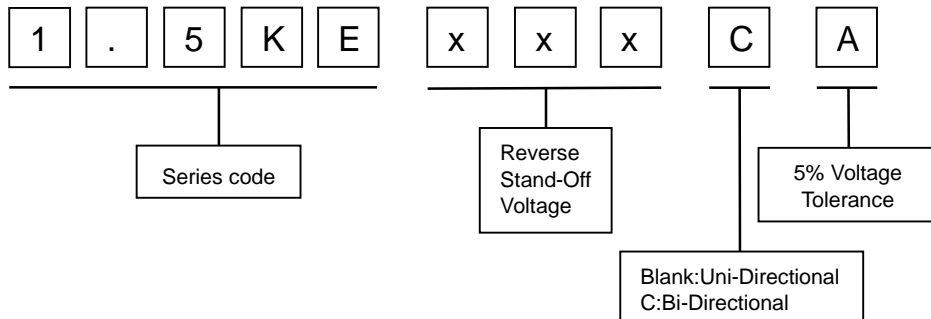

**Mechanical Characteristics**

Rating	Symbol	Value	Units
Peak Pulse Power Dissipation by 10x1000 $\mu s$ test Waveform (Note1) (Fig. 2)	$P_{PP}$	1500	W
Steady State Power Dissipation on infinite heat sink at $T_L=75^\circ C$ (Fig. 6)	$P_D$	5.0	W
Peak Forward Surge Current, 8.3ms Single Half Sine-Wave Unidirectional only (Note 2)	$I_{FSM}$	100	A
Maximum instantaneous forward voltage at 50 A for unidirectional only	$V_F$	3.5/6.5	V
Operating junction and Storage Temperature Range.	$T_J, T_{STG}$	-55 to 150	$^\circ C$

1. Non-repetitive current pulse , per Fig. 4 and derated above  $T_A = 25^\circ C$  per Fig. 3.  
 2. Measured on 8.3ms single half sine-wave or equivalent square wave, duty cycle=4 pulses per minute maximum.



## Electrical Characteristics

Type Number		Reverse Stand-Off Voltage	Breakdown Voltage		Test Current	Max. Clamping Voltage 10/1000µs	Max. Peak Pulse Current 10/1000µs	Reverse Leakage
			V <sub>BR</sub> @I <sub>T</sub>					
		V <sub>RWM</sub>	Min	Max	I <sub>T</sub>	V <sub>C</sub> @I <sub>PP</sub>	I <sub>PP</sub>	I <sub>R</sub> @V <sub>RWM</sub>
UNI	BI	V	V	V	mA	V	A	µA
1.5KE6.8A	1.5KE6.8CA	5.8	6.45	7.14	10	10.5	143.0	1000
1.5KE7.5A	1.5KE7.5CA	6.4	7.13	7.88	10	11.3	132.0	500
1.5KE8.2A	1.5KE8.2CA	7.0	7.79	8.61	10	12.1	124.0	200
1.5KE9.1A	1.5KE9.1CA	7.8	8.6	9.55	1	13.4	112.0	50
1.5KE10A	1.5KE10CA	8.6	9.50	10.50	1	14.5	103.0	10
1.5KE11A	1.5KE11CA	9.4	10.50	11.60	1	15.6	96.0	5
1.5KE12A	1.5KE12CA	10.2	11.40	12.60	1	16.7	90.0	5
1.5KE13A	1.5KE13CA	11.1	12.40	13.70	1	18.2	82.0	1
1.5KE15A	1.5KE15CA	12.8	14.30	15.80	1	21.2	71.0	1
1.5KE16A	1.5KE16CA	13.6	15.20	16.80	1	22.5	67.0	1
1.5KE18A	1.5KE18CA	15.3	17.10	18.90	1	25.2	59.5	1
1.5KE20A	1.5KE20CA	17.1	19.00	21.00	1	27.7	54.0	1
1.5KE22A	1.5KE22CA	18.8	20.90	23.10	1	30.6	49.0	1
1.5KE24A	1.5KE24CA	20.5	22.80	25.20	1	33.2	45.0	1
1.5KE27A	1.5KE27CA	23.1	25.70	28.40	1	37.5	40.0	1
1.5KE30A	1.5KE30CA	25.6	28.50	31.50	1	41.4	36.0	1
1.5KE33A	1.5KE33CA	28.2	31.40	34.70	1	45.7	33.0	1
1.5KE36A	1.5KE36CA	30.8	34.20	37.80	1	49.9	30.0	1
1.5KE39A	1.5KE39CA	33.3	37.10	41.00	1	53.9	28.0	1
1.5KE43A	1.5KE43CA	36.8	40.90	45.20	1	59.3	25.3	1
1.5KE47A	1.5KE47CA	40.2	44.70	49.40	1	64.8	23.2	1
1.5KE51A	1.5KE51CA	43.6	48.50	53.60	1	70.1	21.4	1
1.5KE56A	1.5KE56CA	47.8	53.20	58.80	1	77.0	19.5	1
1.5KE62A	1.5KE62CA	53.0	58.90	65.10	1	85.0	17.7	1
1.5KE68A	1.5KE68CA	58.1	64.60	71.40	1	92.0	16.3	1
1.5KE75A	1.5KE75CA	64.1	71.30	78.80	1	103.0	14.6	1
1.5KE82A	1.5KE82CA	70.1	77.90	86.10	1	113.0	13.3	1
1.5KE91A	1.5KE91CA	77.8	86.50	95.50	1	125.0	12.0	1
1.5KE100A	1.5KE100CA	85.5	95.00	105.00	1	137.0	11.0	1
1.5KE110A	1.5KE110CA	94.0	105.00	116.00	1	152.0	9.9	1



**Electrical Characteristics**

Type Number		Reverse Stand-Off Voltage	Breakdown Voltage		Test Current	Max. Clamping Voltage 10/1000µs	Max. Peak Pulse Current 10/1000µs	Reverse Leakage
			$V_{BR} @ I_T$					
		UNI	BI	$V_{RWM}$	Min	Max	$I_T$	$V_C @ I_{PP}$
		V	V	V	mA	V	A	µA
1.5KE120A	1.5KE120CA	102.0	114.00	126.00	1	165.0	9.1	1
1.5KE130A	1.5KE130CA	111.0	124.00	137.00	1	179.0	8.4	1
1.5KE150A	1.5KE150CA	128.0	143.00	158.00	1	207.0	7.2	1
1.5KE160A	1.5KE160CA	136.0	152.00	168.00	1	219.0	6.8	1
1.5KE170A	1.5KE170CA	145.0	162.00	179.00	1	234.0	6.4	1
1.5KE180A	1.5KE180CA	154.0	171.00	189.00	1	246.0	6.1	1
1.5KE200A	1.5KE200CA	171.0	190.00	210.00	1	274.0	5.5	1
1.5KE220A	1.5KE220CA	185.0	209.00	231.00	1	328.0	4.6	1
1.5KE250A	1.5KE250CA	214.0	237.00	263.00	1	344.0	4.4	1
1.5KE300A	1.5KE300CA	256.0	285.00	315.00	1	414.0	3.6	1
1.5KE350A	1.5KE350CA	300.0	332.00	368.00	1	482.0	3.1	1
1.5KE400A	1.5KE400CA	342.0	380.00	420.00	1	548.0	2.8	1
1.5KE440A	1.5KE440CA	376.0	418.00	462.00	1	602.0	2.5	1
1.5KE480A	1.5KE480CA	408.0	456.00	504.00	1	658.0	2.3	1

**I-V Curve Characteristics**

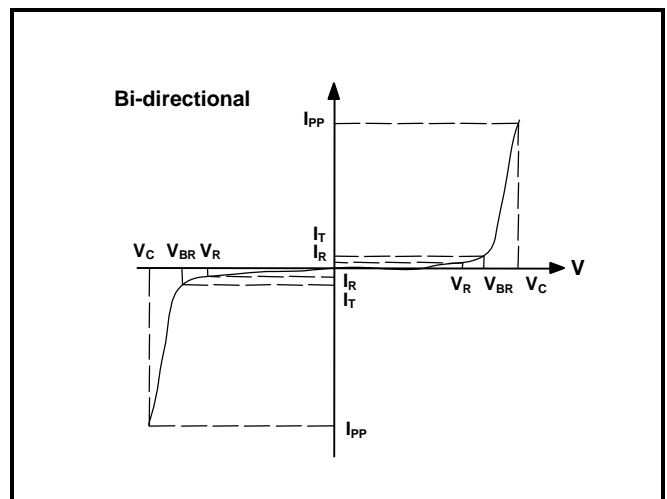
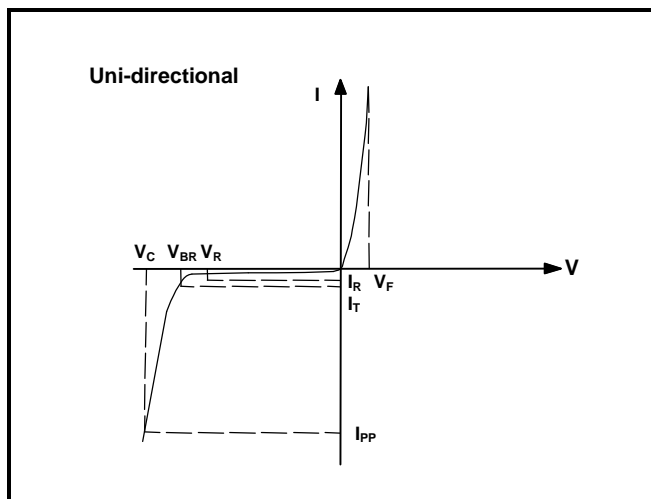

$P_{PPM}$  Peak Pulse Power Dissipation -- Max power dissipation

$V_R$  Stand-off Voltage -- Maximum voltage that can be applied to the TVS without operation

$V_{BR}$  Breakdown Voltage -- Maximum voltage that flows though the TVS at a specified test current ( $I_T$ )

$V_C$  Clamping Voltage -- Peak voltage measured across the TVS at a specified  $I_{ppm}$  (peak impulse current)

$I_R$  Reverse Leakage Current – Current measured at  $V_R$

$V_F$  Forward Voltage Drop for Uni-directional



Ratings and Characteristic Curves ( $T_A=25^\circ\text{C}$  unless otherwise noted)

Figure 1 - TVS Transients Clamping Waveform

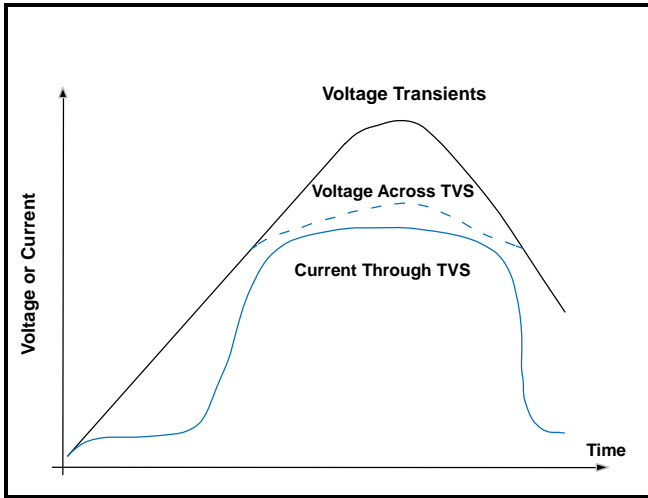

Figure 2 - Peak Pulse Power Rating Curve

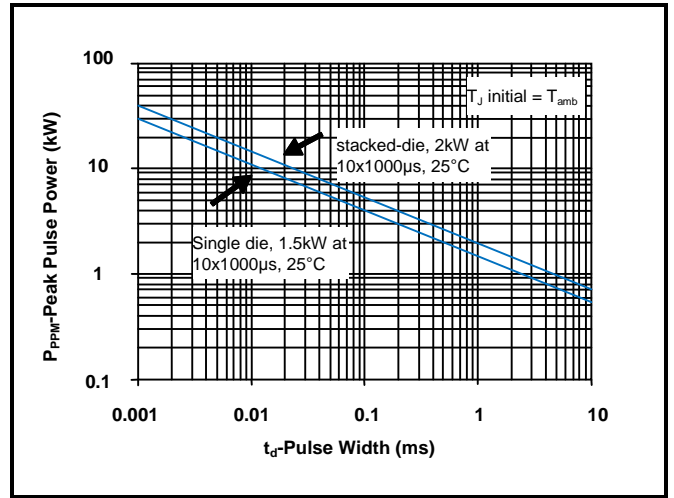

Figure 3 - Pulse Derating Curve

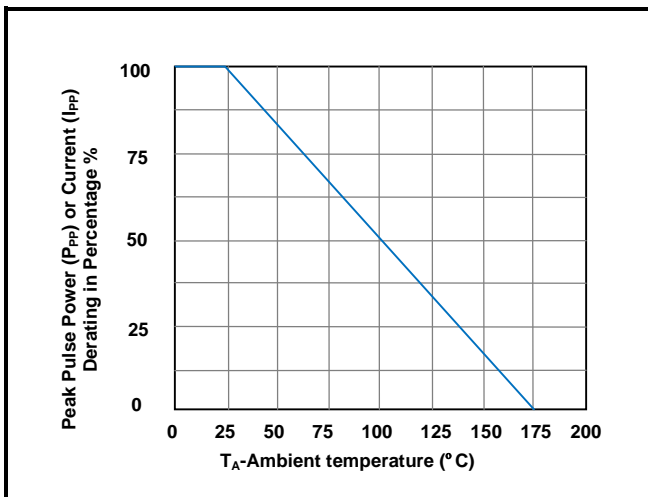

Figure 4 - Pulse Waveform

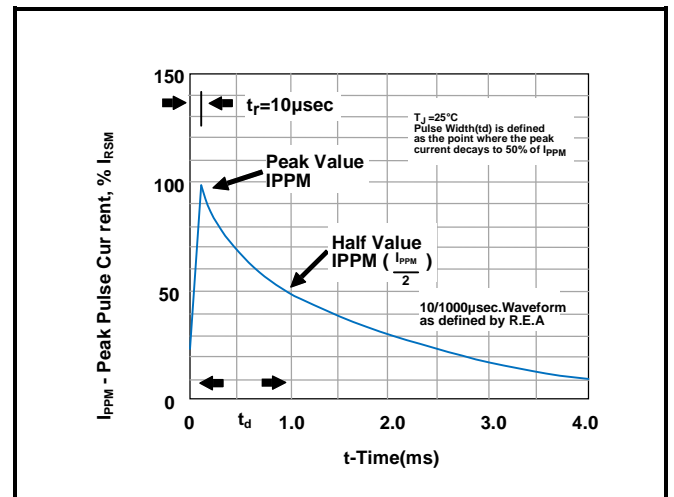

Figure 5 - Typical Junction Capacitance

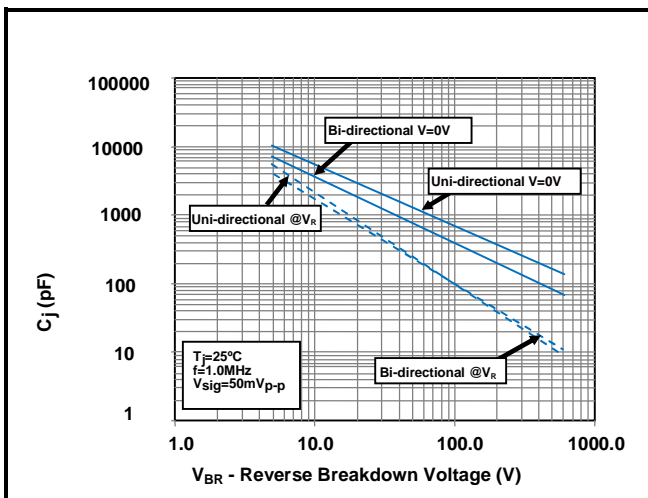

Figure 6 - Steady State Power Derating Curve

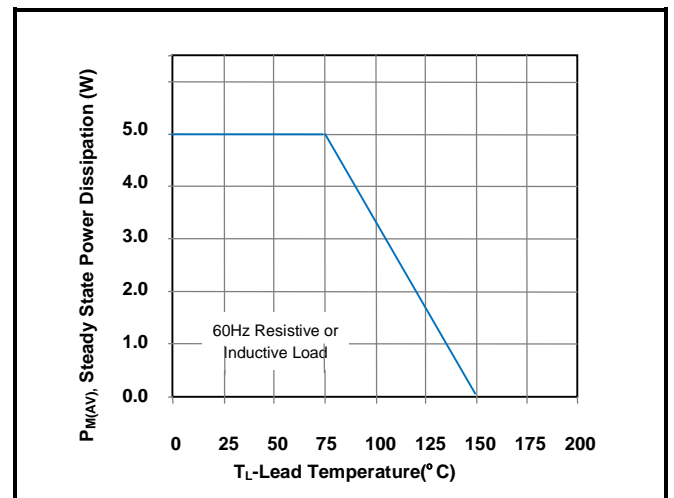
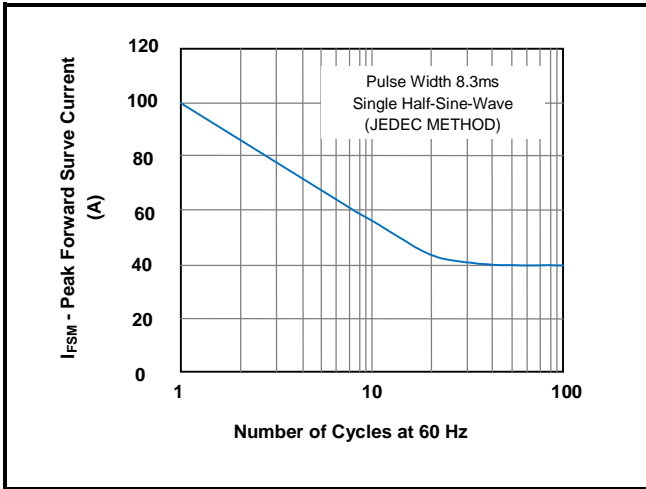
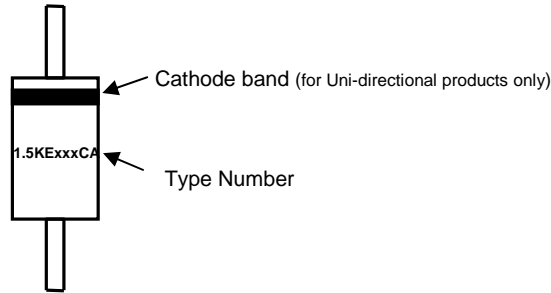

Figure 7 - Maximum Non-Repetitive Surge Current



Part Marking System



Dimensions

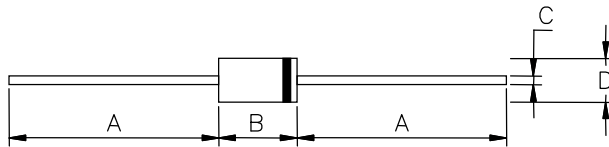

DIM	Millimeters		Inches	
	Min	Max	Min	Max
A	25.40	-	1.000	-
B	7.20	9.50	0.283	0.374
C	0.90	1.30	0.035	0.051
D	4.80	5.50	0.189	0.217



Packaging Information

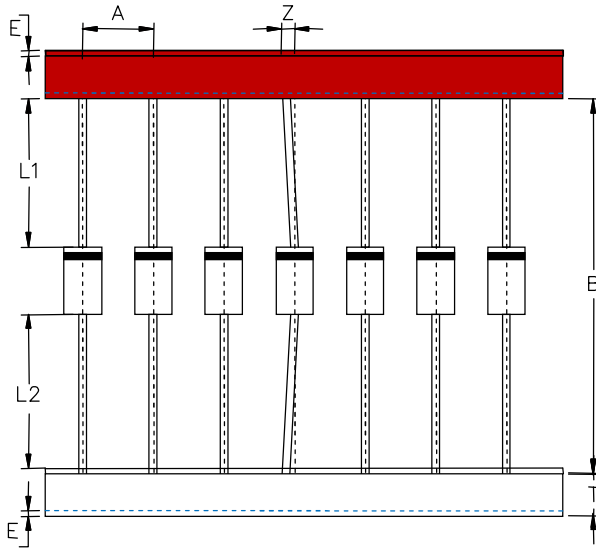

Symbol	Millimeters	Inches
A	10±0.5	0.394±0.019
B	53.0±1.0	2.087±0.039
Z	1.2Max	0.047 Max
T	6.0±0.5	0.236±0.019
E	0.8Max	0.031 Max
L1-L2	1.0Max	0.039 Max

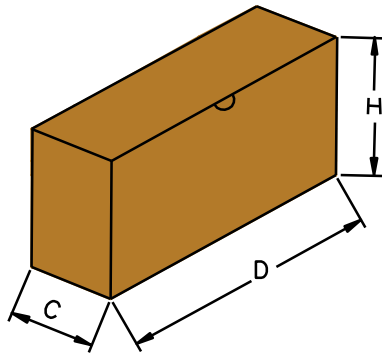

Symbol	Millimeters	Inches
D	250.0±5.0	9.843±0.197
C	75.0±5.0	2.953±0.197
H	114.0±5.0	4.488±0.197
Quantity	1000PCS / inner box	

