

Description

Gas discharge tubes (GDT) use noble gasses enclosed in ceramic tubes to provide an alternate circuit path for voltage spikes. The ceramic envelope and with nickel connectors allow for high loads. SMD4532 Gas Discharge Tubes (GDT) series has a surge rating of 2kA, 8/20µs. Offered in a Squared Surface Mount package, which helps to make pick and place on PCB process easier.

This GDT series is perfectly suited for broadband equipment applications. The GDT's low off-state capacitance is compatible with high bandwidth applications and this capacitance loading value does not vary if the voltage across the GDT changes.

SMD4532 Gas Discharge Tube (GDT) series are specifically designed for protection of electrical, multimedia, and communication equipment against over voltage transients in surface mount assembly applications.



Electrical symbol

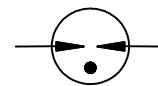

Features

- I Excellent response to fast rising transients
- I Stable breakdown voltage
- I GHz working frequency
- I 8/20µs Impulse current capability: 2KA
- I Surface Mount package
- I Non-Radioactive
- I Ultra Low capacitance(<0.5pF) and insertion loss
- I Lead-free compliant
- I RoHS and REACH compliant
- I UL 497B Recognized: E465335
- I Very Small Size(EIA 1812)
- I Storage and operational temperature: -40~+90°C

Applications

- I Communication equipment
- I CATV equipment
- I Test equipment
- I Data lines
- I Power supplies
- I Telecom SLIC protection
- I Broadband equipment
- I ADSL equipment, including ADSL2+
- I XDSL equipment
- I Satellite and CATV equipment
- I General telecom equipment

Part Number Code

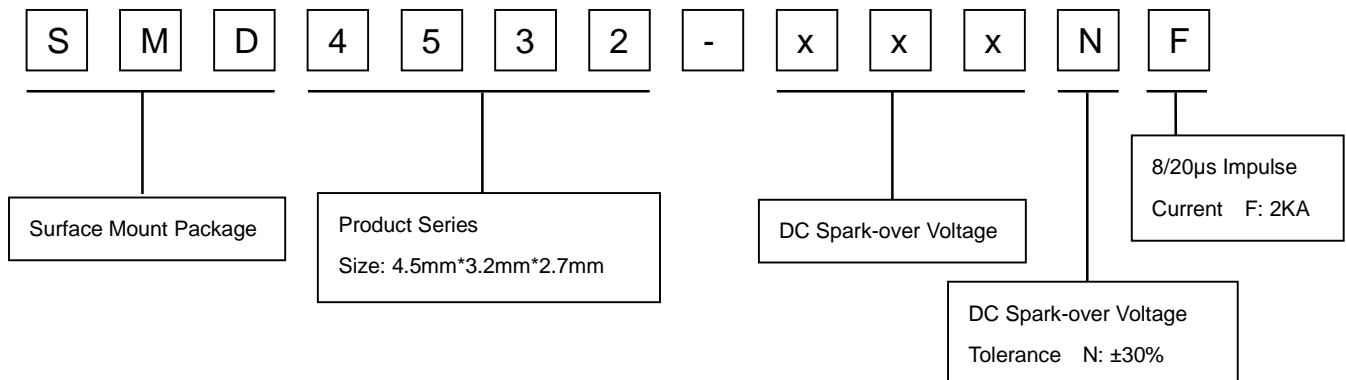

Electrical Characteristics

Part Number	DC Spark-over Voltage ^{1) 2)} @100V/S	Impulse Spark-over Voltage		Insulation Resistance ³⁾	Capacitance @1MHz	Life Ratings				
		100V/μS	1KV/μS			Impulse Discharge Current @8/20μS		AC Discharge Current	Impulse Withstanding Voltage Capacity @10/700μS, 40W ±5 times	Impulse Life @10/1000μS 10A
		Max	Max			Min	Max	Nominal ±5 times		Max 1 time
		V	V	V	GΩ	pF	KA	KA	A	KV
SMD4532-070NF	70±30%	500	600	1	0.5	2	3	2	6	100
SMD4532-075NF	75±30%	500	600	1	0.5	2	3	2	6	100
SMD4532-090NF	90±30%	500	600	1	0.5	2	3	2	6	100
SMD4532-120NF	120±30%	500	600	1	0.5	2	3	1	6	100
SMD4532-150NF	150±30%	500	600	1	0.5	2	3	1	6	100
SMD4532-200NF	200±30%	600	700	1	0.5	2	3	1	6	100
SMD4532-230NF	230±30%	600	700	1	0.5	2	3	1	6	100
SMD4532-300NF	300±30%	700	800	1	0.5	2	3	1	6	100
SMD4532-350NF	350±30%	800	900	1	0.5	2	3	1	6	100
SMD4532-400NF	400±30%	850	950	1	0.5	2	3	1	6	100
SMD4532-420NF	420±30%	850	950	1	0.5	2	3	1	6	100
SMD4532-470NF	470±30%	900	1000	1	0.5	2	3	1	6	100
SMD4532-500NF	500±30%	1000	1100	1	0.5	2	3	1	6	100
SMD4532-600NF	600±30%	1100	1200	1	0.5	2	3	1	6	100
SMD4532-800NF	800±30%	1400	1600	1	0.5	2	3	1	6	100
Glow Voltage at 10mA.....					~60V					
Arc Voltage at 1A.....					~10V					
Glow to Arc transition Current.....					~0.3A					
Weight.....					~0.20g					
Operation and storage temperature.....					-40~+90°C					
Climatic category (IEC 60068-1).....					40/90/21					
Marking.....					Without					
Surface treatment.....					Matte-tin plated					

¹⁾ At delivery AQL 0.65 level II, DIN ISO 2859

²⁾ In ionized mode

³⁾ Insulation Resistance Measuring Voltage:

70V and 75V at DC 25V

90V~150V at DC 50V

Other at DC 100V

Terms in accordance with ITU-T Rec. K.12, IEC 61643-311, GB/T 9043.

Dimensions

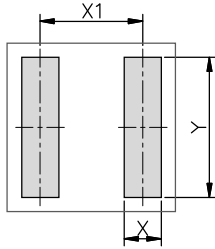
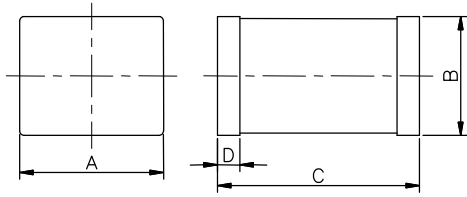

Recommended Soldering Pad Layout

Symbol	Millimeters	Inches
A	3.2±0.2	0.126±0.008
B	2.7±0.2	0.106±0.008
C	4.5±0.3	0.177±0.012
D	0.5±0.1	0.020±0.004
X	1.5	0.059
X1	4.5	0.177
Y	4.2	0.165

Taping and Reel Specifications

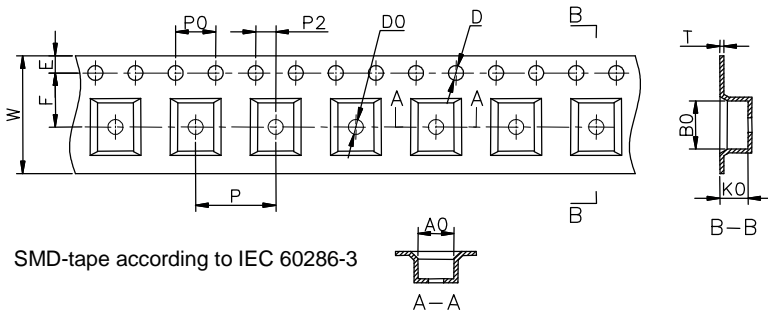

SMD-tape according to IEC 60286-3

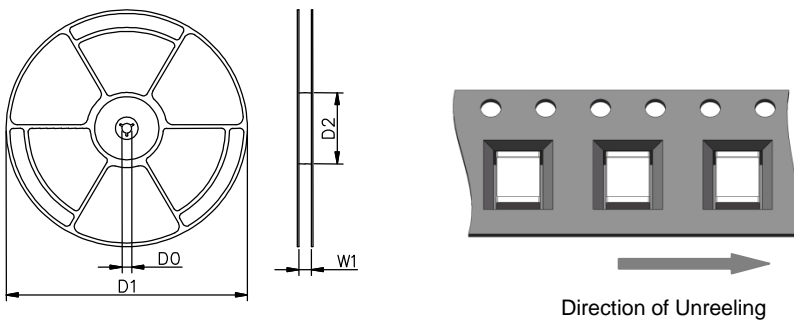

Symbol	Millimeters	Inches
W	12±0.3	0.472±0.012
A0	3.5±0.1	0.138±0.004
B0	5.3±0.1	0.209±0.004
K0	2.9±0.1	0.114±0.004
P	8.0±0.1	0.315±0.004
F	5.5±0.1	0.217±0.004
E	1.75±0.1	0.069±0.004
D	1.5+0.1/-0.0	0.059+0.004/-0.0
P0	4±0.1	0.157±0.004
P2	2±0.1	0.079±0.004
T	0.35±0.05	0.014±0.002
D0	13.3±0.15	0.524±0.006
D1	330±2	12.992±0.079
D2	100+1/-2	3.937+0.039/-0.079
W1	12.5±0.4	0.492±0.016

Packaging Quantity:

- 2,500 PCS per reel (13")
- 4 reels per inner box
- 10,000 PCS per inner box

Soldering Parameters - Reflow Soldering (Surface Mount Devices)

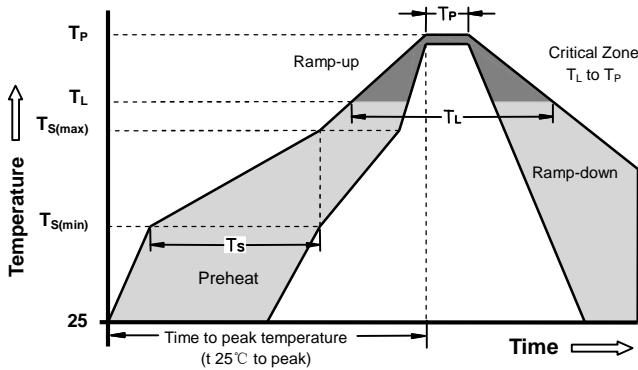

Reflow Condition		Pb - Free assembly
Pre Heat	-Temperature Min ($T_{s(min)}$)	150°C
	-Temperature Max ($T_{s(max)}$)	200°C
	- Time (min to max) (t_s)	60 -180 Seconds
Average ramp up rate (Liquids Temp T_L) to peak		3°C/second max
$T_{s(max)}$ to T_L - Ramp-up Rate		5°C/second max
Reflow	- Temperature (T_L) (Liquids)	217°C
	- Time (min to max) (t_s)	60 -150 Seconds
Peak Temperature (T_P)		260 +0/-5°C
Time within 5°C of actual peak Temperature (t_p)		10 - 30 Seconds
Ramp-down Rate		6°C/second max
Time 25°C to peak Temperature (T_P)		8 minutes Max
Do not exceed		260°C

Surface mounted components (SMD) may exhibit a temporary increase in the DC spark-over voltage after the solder reflow process. The components will recover within 24 hours. There is no quality defect nor change in protection levels during the temporary change in DC spark-over voltage.