

Description

The 3KP Series is designed specifically to protect sensitive electronic equipment from voltage transients induced by lightning and other transient voltage events.

Features

- I Fast response time
- I Matte tin lead-free Plated
- I Low incremental surge resistance
- I Halogen free and RoHS compliant
- I Typical I_R less than 2 μ A above 11V
- I Compatible with industrial standard package P600
- I For surface mounted applications to optimize board space
- I 5000W peak pulse power capability with at 10/1000 μ s waveform, repetition rate (duty cycle): 0.01%
- I High temperature soldering guaranteed:260°C/10 seconds

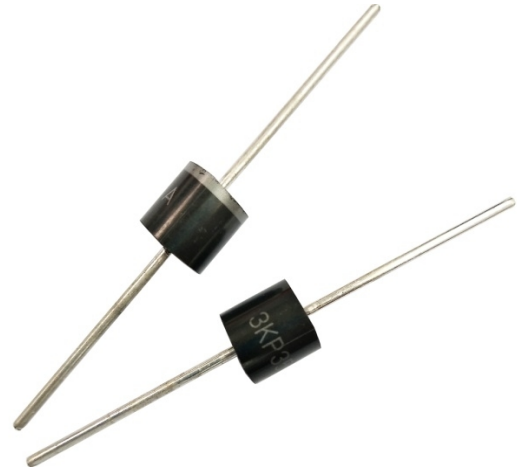

Electrical symbol

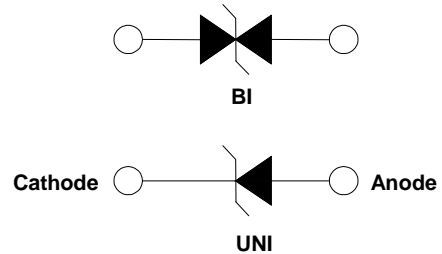

Part Number Code

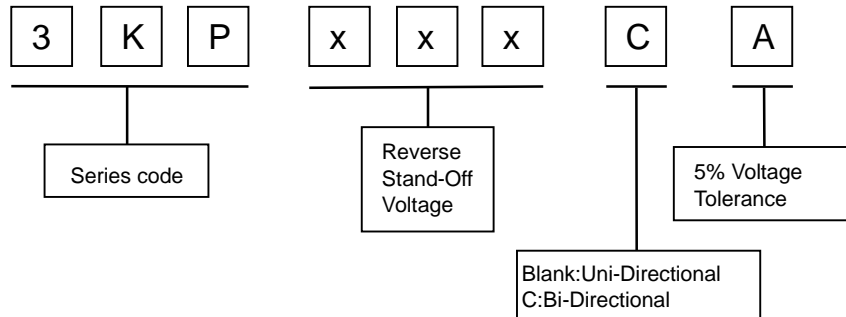

Mechanical Characteristics

Rating	Symbol	Value	Units
Peak Pulse Power Dissipation by 10x1000 μ s test Waveform (Note1)(Fig. 2)	P_{PP}	3000	W
Steady State Power Dissipation on infinite heat sink at $T_L=75^\circ\text{C}$ (Fig. 6)	P_D	6.5	W
Peak Forward Surge Current, 8.3ms Single Half Sine Wave Unidirectional only (Note 2)	I_{FSM}	300	A
Maximum instantaneous forward voltage at 100A for unidirectional only	V_F	3.5/5.0	V
Operating junction and Storage Temperature Range.	T_J, T_{STG}	-55 to 150	$^\circ\text{C}$

Notes:

1. Non-repetitive current pulse , per Fig. 4 and derated above $T_A = 25^\circ\text{C}$ per Fig. 3.
2. Measured on 8.3ms single half sine wave or equivalent square wave, duty cycle=4 pulses per minute maximum.



Electrical Characteristics

Type Number		Reverse Stand-Off Voltage	Breakdown Voltage		Test Current	Max. Clamping Voltage 10/1000µs	Max. Peak Pulse Current 10/1000µs	Reverse Leakage
			$V_{BR} @ I_T$					
		V_{RWM}	Min	Max	I_T	$V_C @ I_{PP}$	I_{PP}	$I_R @ V_{RWM}$
UNI	BI	V	V	V	mA	V	A	µA
3KP5.0A	3KP5.0CA	5.0	6.40	7.00	50	9.2	326.09	5000
3KP6.0A	3KP6.0CA	6.0	6.67	7.37	50	10.3	291.26	5000
3KP6.5A	3KP6.5CA	6.5	7.22	7.98	50	11.2	267.86	2000
3KP7.0A	3KP7.0CA	7.0	7.78	8.60	50	12.0	250.00	1000
3KP7.5A	3KP7.5CA	7.5	8.33	9.21	5	12.9	232.56	250
3KP8.0A	3KP8.0CA	8.0	8.89	9.83	5	13.6	220.59	150
3KP8.5A	3KP8.5CA	8.5	9.44	10.40	5	14.4	208.33	50
3KP9.0A	3KP9.0CA	9.0	10.00	11.10	5	15.4	194.81	20
3KP10A	3KP10CA	10.0	11.10	12.30	5	17.0	176.47	15
3KP11A	3KP11CA	11.0	12.20	13.50	5	18.2	164.84	2
3KP12A	3KP12CA	12.0	13.30	14.70	5	19.9	150.75	2
3KP13A	3KP13CA	13.0	14.40	15.90	5	21.5	139.53	2
3KP14A	3KP14CA	14.0	15.60	17.20	5	23.2	129.31	2
3KP15A	3KP15CA	15.0	16.70	18.50	5	24.4	122.95	2
3KP16A	3KP16CA	16.0	17.80	19.70	5	26.0	115.38	2
3KP17A	3KP17CA	17.0	18.90	20.90	5	27.6	108.70	2
3KP18A	3KP18CA	18.0	20.00	22.10	5	29.2	102.74	2
3KP19A	3KP19CA	19.0	21.10	23.30	5	30.8	97.47	2
3KP20A	3KP20CA	20.0	22.20	24.50	5	32.4	92.59	2
3KP22A	3KP22CA	22.0	24.40	26.90	5	35.5	84.51	2
3KP24A	3KP24CA	24.0	26.70	29.50	5	38.9	77.12	2
3KP26A	3KP26CA	26.0	28.90	31.90	5	42.1	71.26	2
3KP28A	3KP28CA	28.0	31.10	34.40	5	45.4	66.08	2
3KP30A	3KP30CA	30.0	33.30	36.80	5	48.4	61.98	2
3KP33A	3KP33CA	33.0	36.70	40.60	5	53.3	56.29	2
3KP36A	3KP36CA	36.0	40.00	44.20	5	58.1	51.64	2
3KP40A	3KP40CA	40.0	44.40	49.10	5	64.5	46.51	2
3KP43A	3KP43CA	43.0	47.80	52.80	5	69.4	43.23	2
3KP45A	3KP45CA	45.0	50.00	55.30	5	72.7	41.27	2
3KP48A	3KP48CA	48.0	53.30	58.90	5	77.4	38.76	2



Electrical Characteristics

Type Number		Reverse Stand-Off Voltage	Breakdown Voltage		Test Current	Max. Clamping Voltage 10/1000µs	Max. Peak Pulse Current 10/1000µs	Reverse Leakage
			V _{BR} @I _T					
		V _{RWM}	Min	Max	I _T	V _C @I _{PP}	I _{PP}	I _R @V _{RWM}
UNI	BI	V	V	V	mA	V	A	µA
3KP51A	3KP51CA	51.0	56.70	62.70	5	82.4	36.41	2
3KP54A	3KP54CA	54.0	60.00	66.30	5	87.1	34.44	2
3KP58A	3KP58CA	58.0	64.40	71.20	5	93.6	32.05	2
3KP60A	3KP60CA	60.0	66.70	73.70	5	96.8	30.99	2
3KP64A	3KP64CA	64.0	71.10	78.60	5	103.0	29.13	2
3KP70A	3KP70CA	70.0	77.80	86.00	5	113.0	26.55	2
3KP75A	3KP75CA	75.0	83.30	92.10	5	121.0	24.79	2
3KP78A	3KP78CA	78.0	86.70	95.80	5	126.0	23.81	2
3KP80A	3KP80CA	80.0	88.80	97.60	5	129.6	23.15	2
3KP85A	3KP85CA	85.0	94.40	104.00	5	137.0	21.90	2
3KP90A	3KP90CA	90.0	100.00	111.00	5	146.0	20.55	2
3KP100A	3KP100CA	100.0	111.00	123.00	5	162.0	18.52	2
3KP110A	3KP110CA	110.0	122.00	135.00	5	177.0	16.95	2
3KP120A	3KP120CA	120.0	133.00	147.00	5	193.0	15.54	2
3KP130A	3KP130CA	130.0	144.00	159.00	5	209.0	14.35	2
3KP140A	3KP140CA	140.0	155.00	171.00	5	226.8	13.23	2
3KP150A	3KP150CA	150.0	167.00	185.00	5	243.0	12.35	2
3KP160A	3KP160CA	160.0	178.00	197.00	5	259.0	11.58	2
3KP170A	3KP170CA	170.0	189.00	209.00	5	275.0	10.91	2
3KP180A	3KP180CA	180.0	200.00	220.00	5	291.6	10.29	2
3KP190A	3KP190CA	190.0	211.00	232.00	5	307.8	9.75	2
3KP200A	3KP200CA	200.0	224.00	247.00	5	324.0	9.26	2
3KP210A	3KP210CA	210.0	233.00	258.00	5	349.5	8.58	2
3KP220A	3KP220CA	220.0	246.00	272.00	5	356.0	8.43	2
3KP250A	3KP250CA	250.0	279.00	309.00	5	405.0	7.41	2
3KP300A	3KP300CA	300.0	335.00	371.00	5	486.0	6.17	2
3KP350A	3KP350CA	350.0	391.00	432.00	5	567.0	5.29	2
3KP400A	3KP400CA	400.0	447.00	494.00	5	648.0	4.63	2
3KP440A	3KP440CA	440.0	492.00	543.00	5	713.0	4.21	2

Notes: For bidirectional type having V_R of 10V and less, the I_R limit is double.



I-V Curve Characteristics

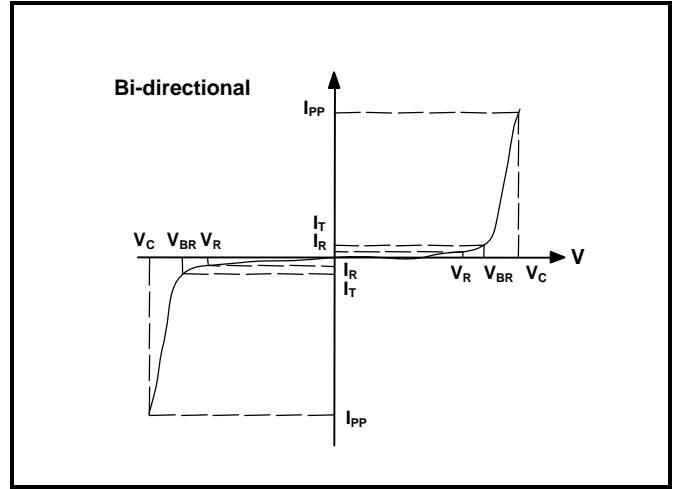
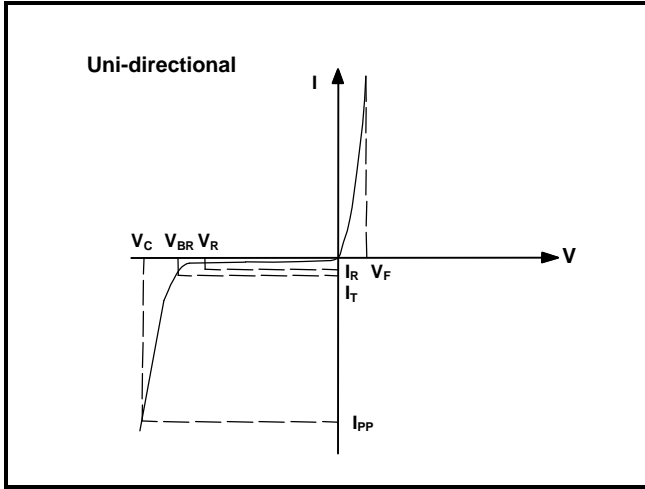

P_{PPM} Peak Pulse Power Dissipation -- Max power dissipation

V_R Stand-off Voltage -- Maximum voltage that can be applied to the TVS without operation

V_{BR} Breakdown Voltage -- Maximum voltage that flows through the TVS at a specified test current (I_T)

V_C Clamping Voltage -- Peak voltage measured across the TVS at a specified I_{ppm} (peak impulse current)

I_R Reverse Leakage Current – Current measured at V_R

V_F Forward Voltage Drop for Uni-directional

Ratings and Characteristic Curves ($T_A=25^\circ C$ unless otherwise noted)

Figure 1 - TVS Transients Clamping Waveform

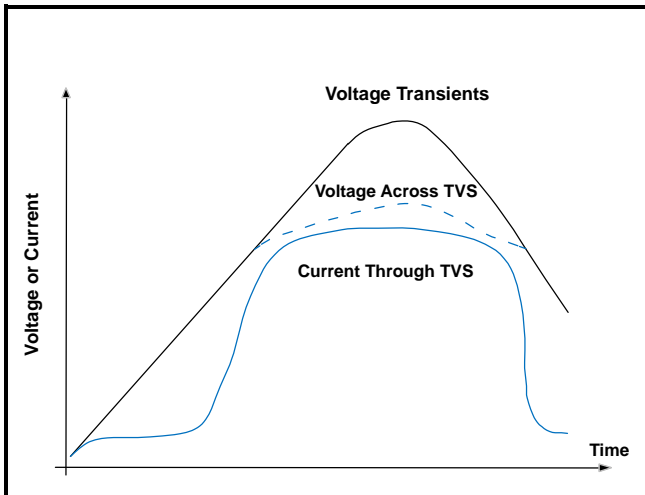
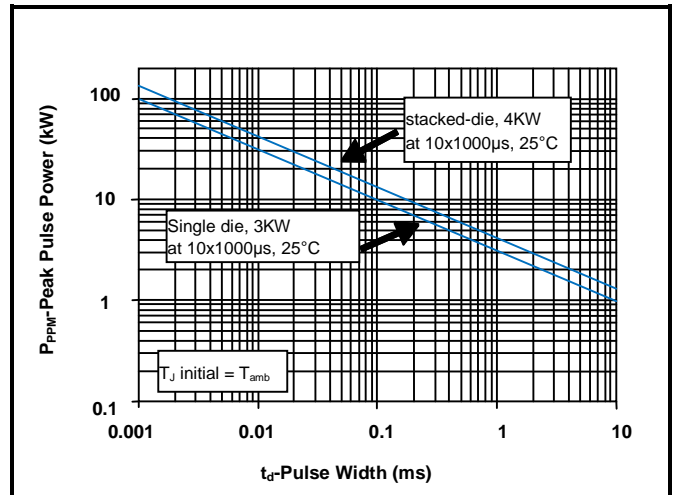

Figure 2 - Peak Pulse Power Rating Curve



Ratings and Characteristic Curves ($T_A=25^\circ\text{C}$ unless otherwise noted) (Continued)

Figure 3 - Pulse Derating Curve

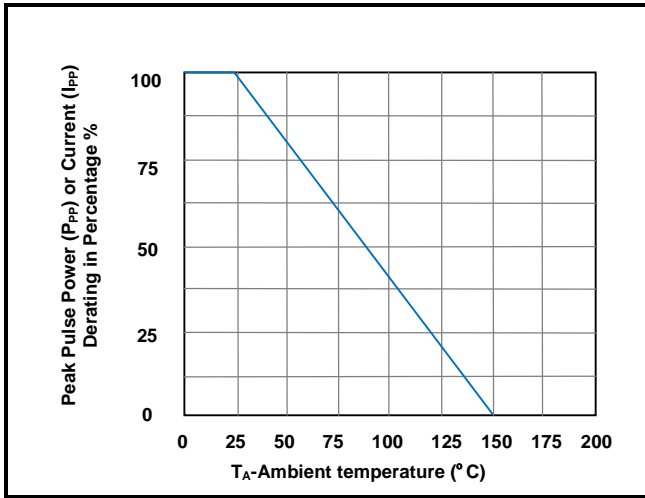

Figure 4 - Pulse Waveform

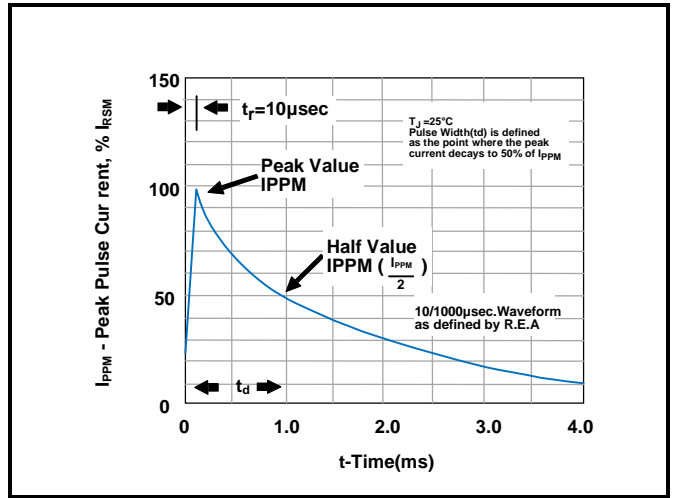

Figure 5 - Typical Junction Capacitance

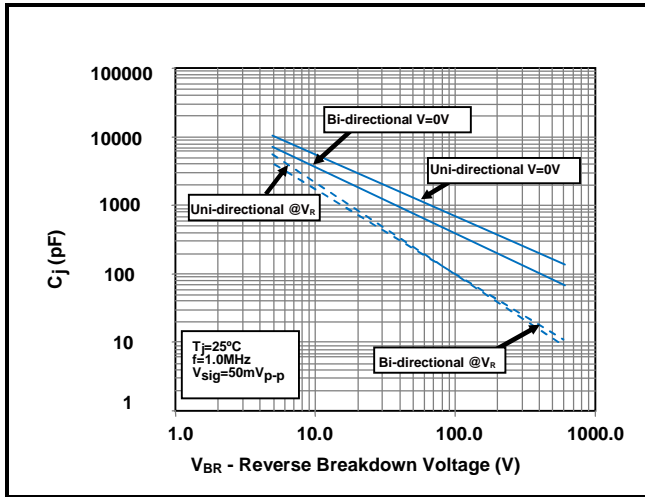

Figure 6 - Steady State Power Derating Curve

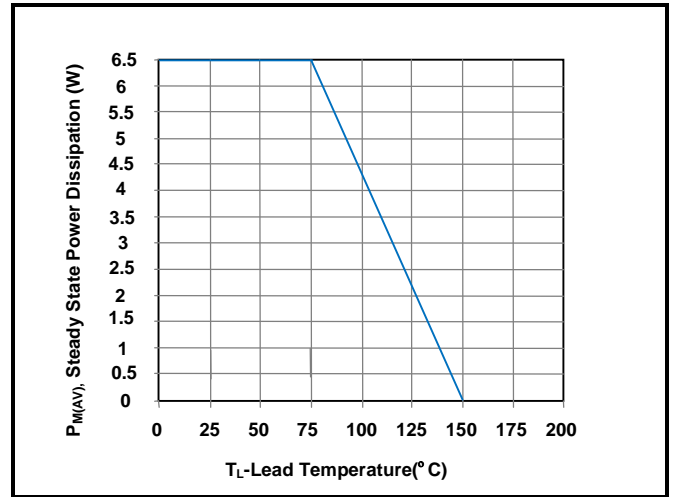
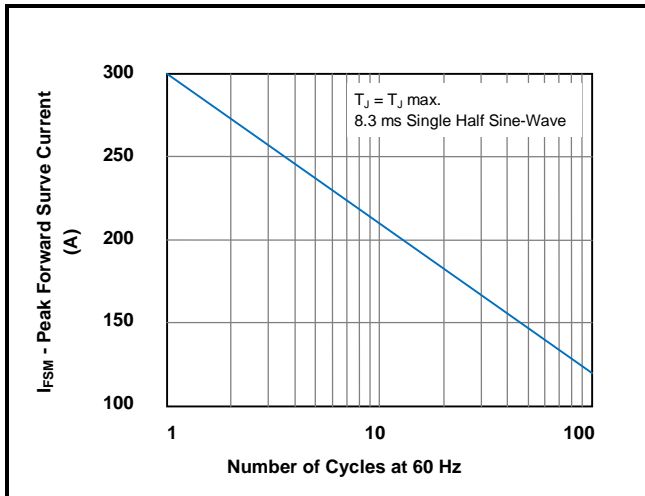
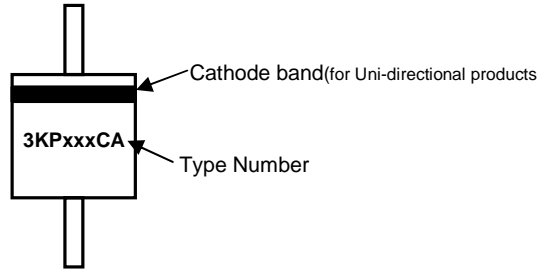

Figure 7 - Maximum Non-Repetitive Surge Current



Part Marking System



Dimensions

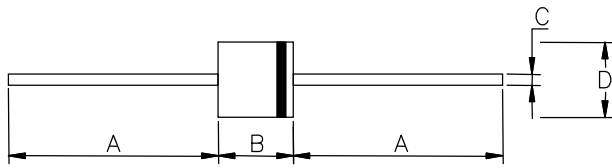

DIM	Millimeters		Inches	
	Min	Max	Min	Max
A	25.40	-	1.000	-
B	8.60	9.14	0.340	0.360
C	1.20	1.32	0.048	0.052
D	8.60	9.14	0.340	0.360

Packaging Information

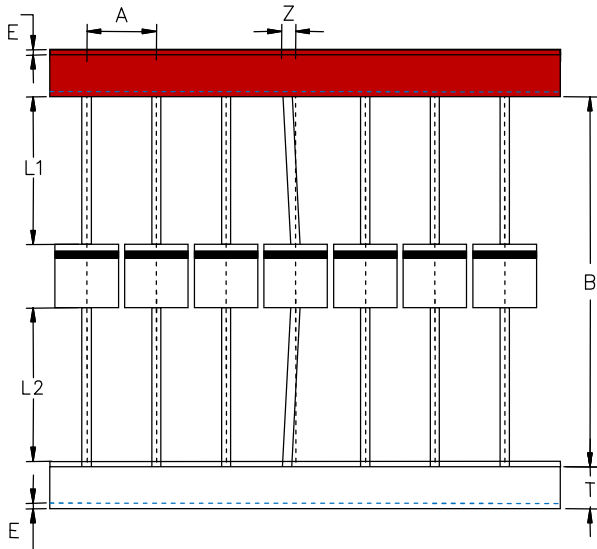

Symbol	Millimeters	Inches
A	10±0.5	0.394±0.019
B	53.0±1.0	2.087±0.039
Z	1.2Max	0.047 Max
T	6.0±0.5	0.236±0.019
E	0.8Max	0.031 Max
L1-L2	1.0Max	0.039 Max

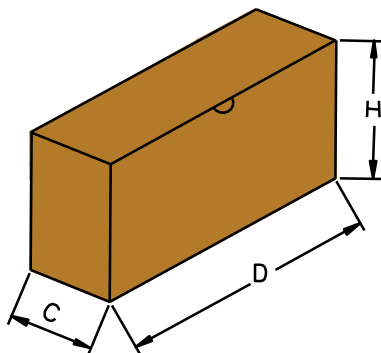

Symbol	Millimeters	Inches
D	250.0±5.0	9.843±0.197
C	75.0±5.0	2.953±0.197
H	114.0±5.0	4.488±0.197
Quantity	400PCS/ inner box	

