

Description

The 20KPA Series is designed specifically to protect sensitive electronic equipment from voltage transients induced by lightning and other transient voltage events.

Features

- I Fast response time
- I Matte tin lead-free Plated
- I Low incremental surge resistance
- I Halogen free and RoHS compliant
- I Typical I_R less than $2\mu A$ above 40V
- I Compatible with industrial standard package P600
- I For surface mounted applications to optimize board space
- I 20000W peak pulse power capability with at 10/1000 μs waveform, repetition rate (duty cycle): 0.01%
- I High temperature soldering guaranteed:260°C/ 10 seconds



Electrical symbol

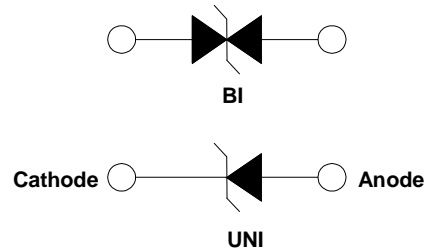

Part Number Code

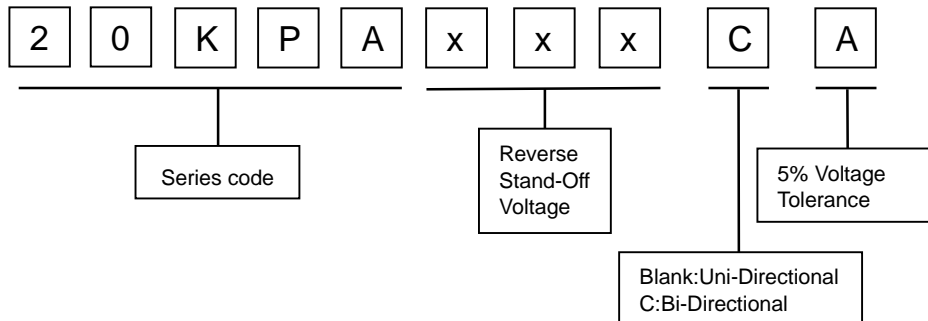

Mechanical Characteristics

Rating	Symbol	Value	Units
Peak Pulse Power Dissipation by 10x1000 μs test Waveform (Note1)(Fig. 2)	P_{PP}	20000	W
Steady State Power Dissipation on infinite heat sink at $T_L=75^\circ C$ (Fig. 6)	P_D	8	W
Peak Forward Surge Current, 8.3ms Single Half Sine Wave Unidirectional only (Note 2)	I_{FSM}	500	A
Maximum instantaneous forward voltage at 25A for unidirectional only	V_F	3.5/5.0	V
Operating junction and Storage Temperature Range.	T_J, T_{STG}	-55 to 150	$^\circ C$

Notes:

1. Non-repetitive current pulse , per Fig. 4 and derated above $T_A = 25^\circ C$ per Fig. 3.
2. Measured on 8.3ms single half sine wave or equivalent square wave, duty cycle=4 per minute maximum.



Electrical Characteristics

Type Number		Reverse Stand-Off Voltage	Breakdown Voltage		Test Current	Max. Clamping Voltage 10/1000µs	Max. Peak Pulse Current 10/1000µs	Reverse Leakage
			V _{BR} @I _T					
		V _{RWM}	Min	Max	I _T	V _C @IPP	I _{PP}	I _R @V _{RWM}
UNI	BI	V	V	V	mA	V	A	µA
20KPA20A	20KPA20CA	20.0	22.34	24.57	50	36.8	548.9	5000
20KPA24A	20KPA24CA	24.0	26.81	29.49	50	41.2	490.3	5000
20KPA26A	20KPA26CA	26.0	29.04	31.94	50	44.7	451.9	2000
20KPA28A	20KPA28CA	28.0	31.28	34.41	50	48.0	420.8	1000
20KPA30A	20KPA30CA	30.0	33.51	36.86	5	51.5	392.2	250
20KPA32A	20KPA32CA	32.0	35.74	39.31	5	54.3	372.0	150
20KPA34A	20KPA34CA	34.0	38.00	41.80	5	57.5	351.3	50
20KPA36A	20KPA36CA	36.0	40.20	44.22	5	61.5	328.5	20
20KPA40A	20KPA40CA	40.0	44.70	49.17	5	67.8	297.9	15
20KPA44A	20KPA44CA	44.0	49.10	54.01	5	72.7	277.9	2
20KPA48A	20KPA48CA	48.0	53.60	58.96	5	79.4	254.4	2
20KPA52A	20KPA52CA	52.0	58.10	63.91	5	85.8	235.4	2
20KPA56A	20KPA56CA	56.0	62.60	68.86	5	92.6	218.1	2
20KPA60A	20KPA60CA	60.0	67.00	73.70	5	97.6	207.0	2
20KPA64A	20KPA64CA	64.0	71.50	78.65	5	104.0	194.2	2
20KPA68A	20KPA68CA	68.0	76.00	83.60	5	110.0	183.6	2
20KPA72A	20KPA72CA	72.0	80.40	88.44	5	116.0	174.1	2
20KPA80A	20KPA80CA	80.0	89.40	98.34	5	130.0	155.4	2
20KPA88A	20KPA88CA	88.0	98.30	108.13	5	142.0	142.3	2
20KPA96A	20KPA96CA	96.0	107.20	117.92	5	155.0	130.3	2
20KPA104A	20KPA104CA	104.0	116.20	127.82	5	168.0	120.2	2
20KPA112A	20KPA112CA	112.0	125.10	137.61	5	182.0	111.0	2
20KPA120A	20KPA120CA	120.0	134.00	147.40	5	194.0	104.1	2
20KPA132A	20KPA132CA	132.0	147.40	162.14	5	213.0	94.8	2
20KPA144A	20KPA144CA	144.0	160.80	176.88	5	232.0	87.1	2
20KPA160A	20KPA160CA	160.0	178.70	196.57	5	258.0	78.3	2
20KPA172A	20KPA172CA	172.0	192.10	211.31	5	277.0	72.9	2
20KPA180A	20KPA180CA	180.0	201.10	221.21	5	291.0	69.4	2
20KPA192A	20KPA192CA	192.0	214.50	235.95	5	309.0	65.4	2
20KPA204A	20KPA204CA	204.0	227.90	250.96	5	329.0	61.4	2
20KPA216A	20KPA216CA	216.0	241.30	265.43	5	348.0	58.0	2
20KPA232A	20KPA232CA	232.0	259.10	285.01	5	374.0	54.0	2
20KPA240A	20KPA240CA	240.0	268.10	294.91	5	387.0	52.2	2
20KPA256A	20KPA256CA	256.0	286.00	314.60	5	412.0	49.0	2
20KPA280A	20KPA280CA	280.0	312.80	344.08	5	451.0	44.8	2
20KPA300A	20KPA300CA	300.0	335.10	368.61	5	483.0	41.8	2



I-V Curve Characteristics

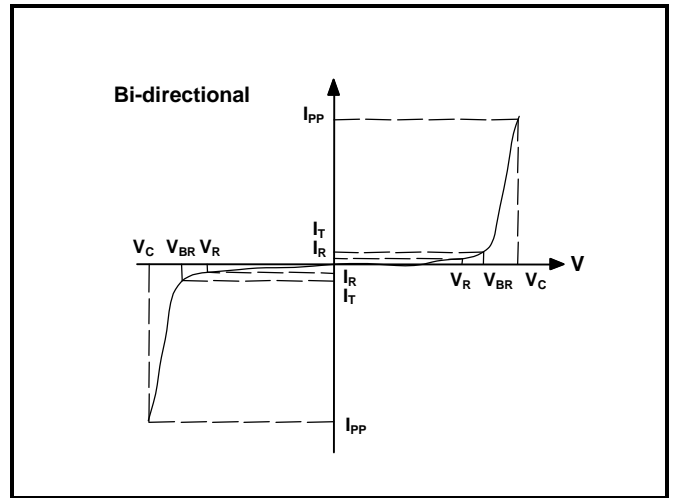
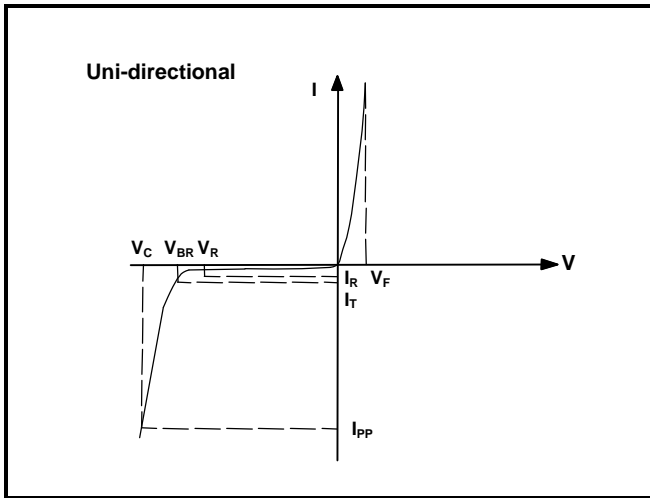

P_{PPM} Peak Pulse Power Dissipation -- Max power dissipation

V_R Stand-off Voltage -- Maximum voltage that can be applied to the TVS without operation

V_{BR} Breakdown Voltage -- Maximum voltage that flows though the TVS at a specified test current (I_T)

V_C Clamping Voltage -- Peak voltage measured across the TVS at a specified I_{ppm} (peak impulse current)

I_R Reverse Leakage Current – Current measured at V_R

V_F Forward Voltage Drop for Uni-directional

Ratings and Characteristic Curves ($T_A=25^\circ C$ unless otherwise noted)

Figure 1 - TVS Transients Clamping Waveform

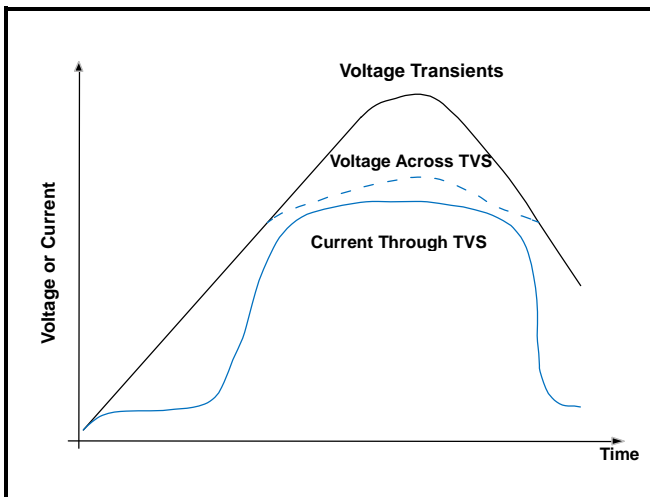

Figure 2 - Peak Pulse Power Rating Curve

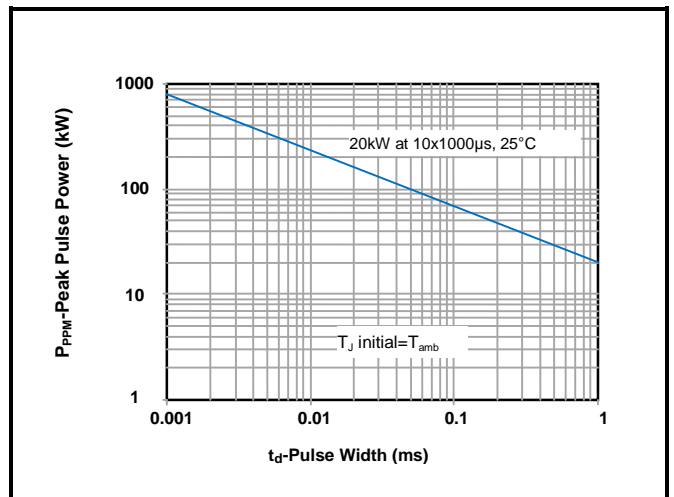

Figure 3 - Pulse Derating Curve

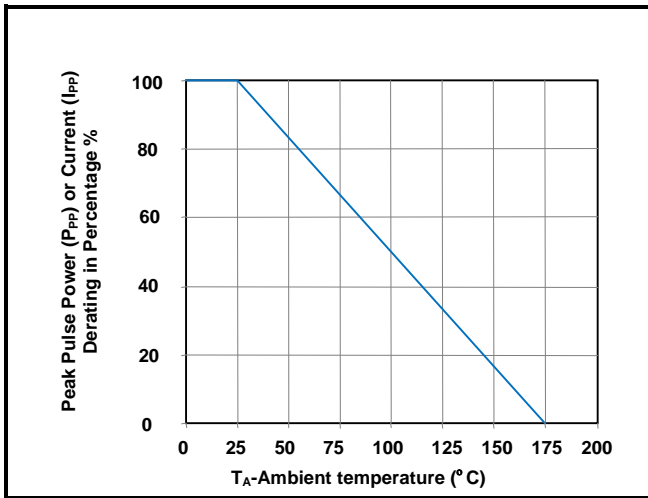

Figure 4 - Pulse Waveform

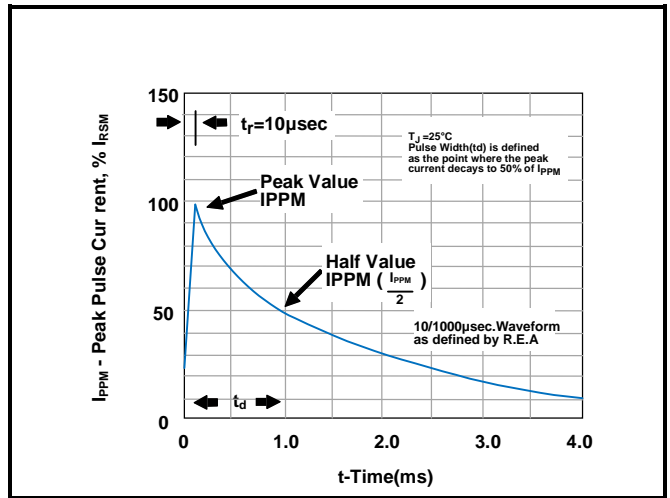

Figure 5 - Typical Junction Capacitance

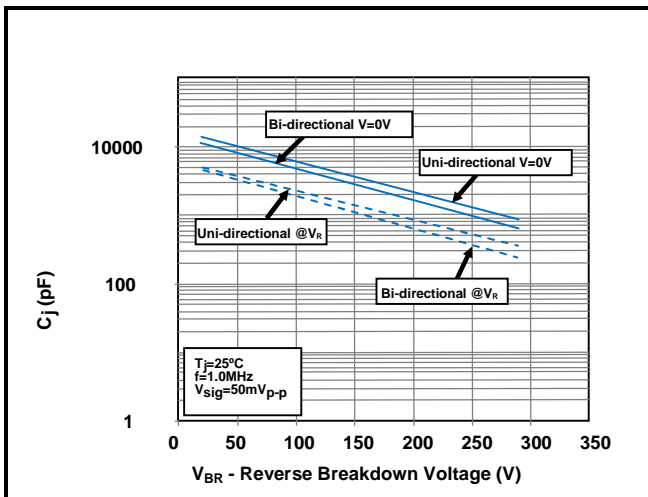

Figure 6 - Steady State Power Derating Curve

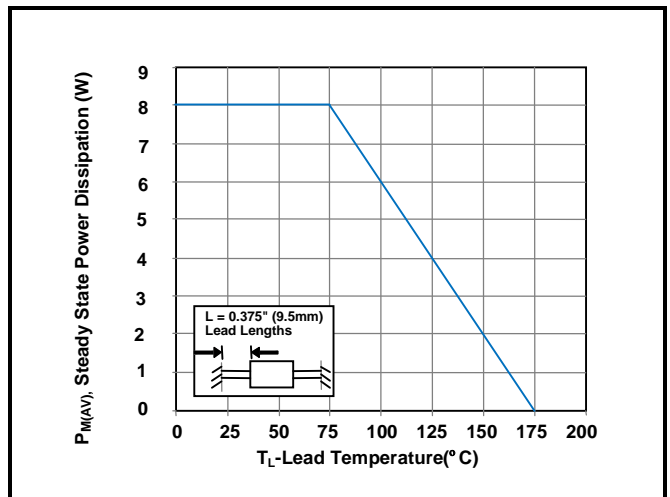
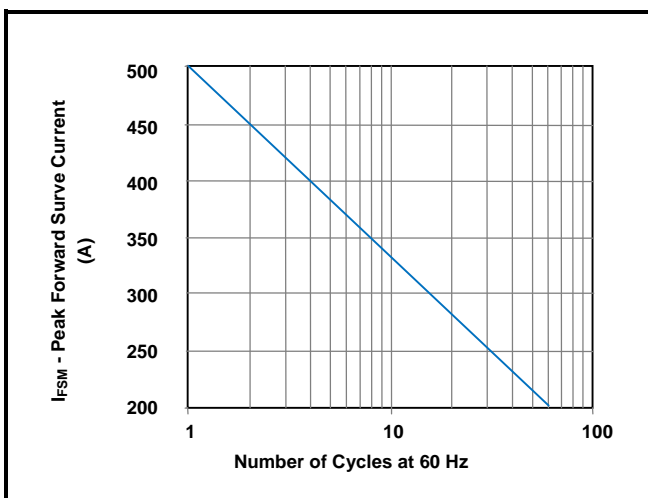
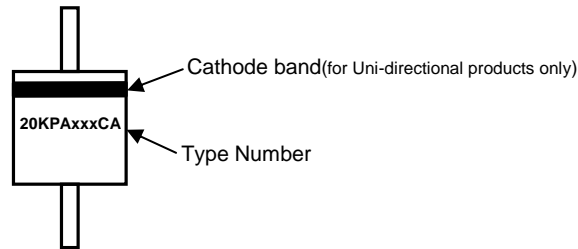

Figure 7 - Maximum Non-Repetitive Surge Current



Part Marking System



Dimensions

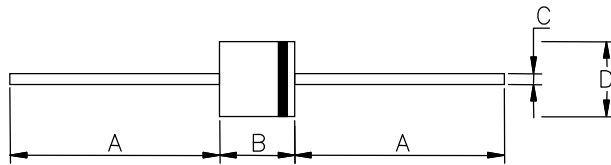

DIM	Millimeters		Inches	
	Min	Max	Min	Max
A	25.40	-	1.000	-
B	8.6	9.14	0.339	0.360
C	1.2	1.32	0.047	0.052
D	8.6	9.14	0.339	0.360

Packaging Information

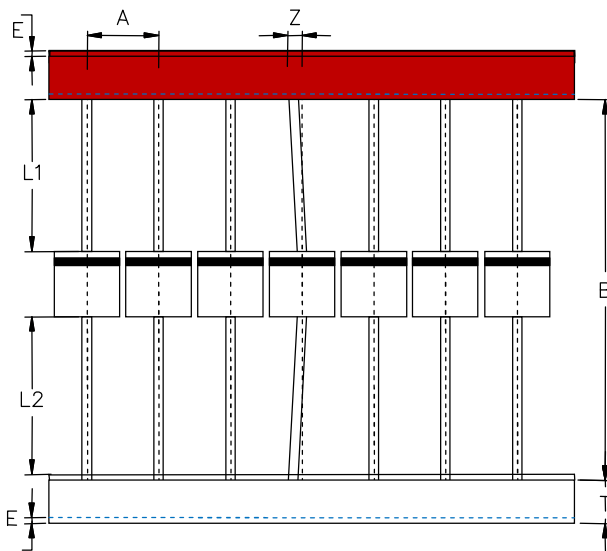

Symbol	Millimeters	Inches
A	10±0.5	0.394±0.019
B	53.0±1.0	2.087±0.039
Z	1.2Max	0.047 Max
T	6.0±0.5	0.236±0.019
E	0.8Max	0.031 Max
L1-L2	1.0Max	0.039 Max

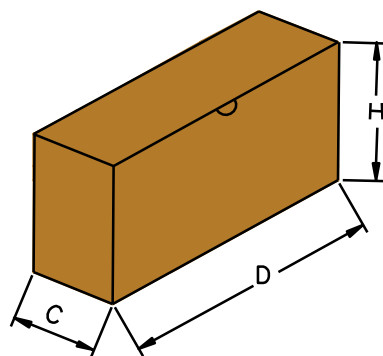

Symbol	Millimeters	Inches
D	250.0±5.0	9.843±0.197
C	75.0±5.0	2.953±0.197
H	114.0±5.0	4.488±0.197
Quantity	400PCS/ inner box	

