

**Description**

The 5.0SMDJ series is designed specifically to protect sensitive electronic equipment from voltage transients induced by lightning and other transient voltage events.

**Features**

- I Very fast response time
- I Matte tin lead-free Plated
- I Halogen free and RoHS compliant
- I Low incremental surge resistance
- I Typical  $I_R$  less than  $5\mu A$  above 19V
- I Compatible with industrial standard package DO-214AB
- I For surface mounted applications to optimize board space
- I 5000W peak pulse power capability with at 10/1000 $\mu s$  waveform, repetition rate (duty cycle): 0.01%
- I High temperature soldering: 260°C/ 10 seconds at terminals

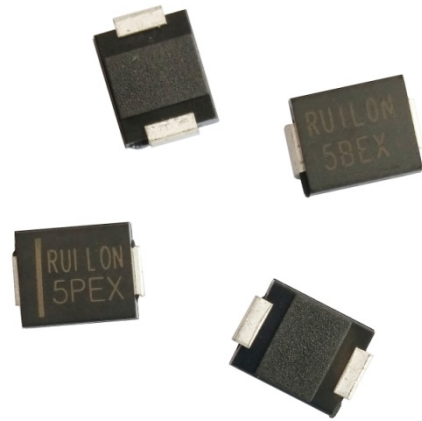

**Electrical symbol**

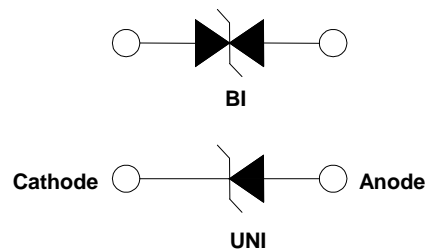

**Part Number Code**

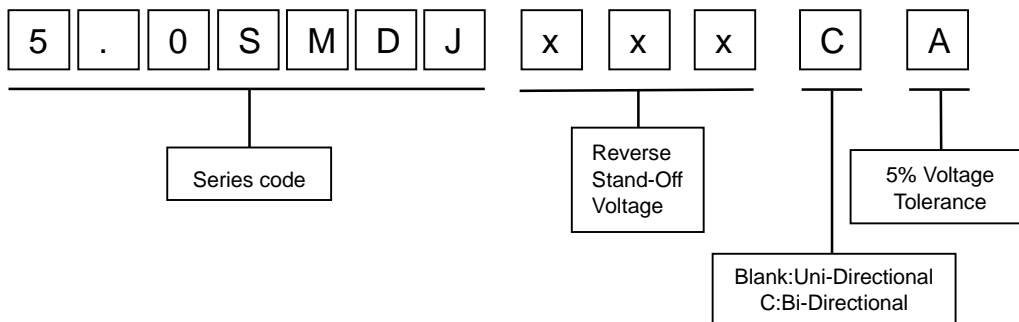

**Mechanical Characteristics**

Rating	Symbol	Value	Units
Peak Pulse Power Dissipation at $T_A=25^\circ C$ by 10/1000 $\mu s$ Waveform (Fig.2)(Note 1), (Note 2)	$P_{PP}$	5000	W
Power Dissipation on Infinite Heat Sink at $T_L=75^\circ C$ (Fig.6)	$P_D$	6.5	W
Peak Forward Surge Current, 8.3ms Single Half Sine Wave (Note 3)	$I_{FSM}$	300	A
Operating Temperature Range	$T_J$	-55 to 150	$^\circ C$
Storage Temperature Range	$T_{STG}$	-55 to 150	$^\circ C$

1. Non-repetitive current pulse , per Fig. 4 and derated above  $T_A = 25^\circ C$  per Fig. 3.  
 2. Mounted on copper pad area of 0.31x0.31" (8.0 x 8.0mm) to each terminal.  
 3. Measured on 8.3ms single half sine wave or equivalent square wave for unidirectional device only, duty cycle=4 per minute maximum.



**Electrical Characteristics**

Type Number		Marking		Reverse Stand-Off Voltage	Breakdown Voltage		Test Current	Max. Clamping Voltage	Max. Peak Pulse Current	Reverse Leakage
				V <sub>R</sub>	V <sub>BR</sub> @I <sub>T</sub>		I <sub>T</sub>	V <sub>C</sub> @I <sub>PP</sub>	I <sub>PP</sub>	I <sub>R</sub> @V <sub>R</sub>
					Min	Max				
UNI	BI	UNI	BI	V	V	V	mA	V	A	μA
5.0SMDJ11A	5.0SMDJ11CA	5PDX	5BDX	11.0	12.20	13.50	10	18.2	274.73	800
5.0SMDJ12A	5.0SMDJ12CA	5PDZ	5BDZ	12.0	13.30	14.70	10	19.9	251.26	800
5.0SMDJ13A	5.0SMDJ13CA	5PEE	5BEE	13.0	14.40	15.90	10	21.5	232.56	500
5.0SMDJ14A	5.0SMDJ14CA	5PEG	5BEG	14.0	15.60	17.20	10	23.2	215.52	200
5.0SMDJ15A	5.0SMDJ15CA	5PEK	5BEK	15.0	16.70	18.50	1	24.4	204.92	100
5.0SMDJ16A	5.0SMDJ16CA	5PEM	5BEM	16.0	17.80	19.70	1	26.0	192.31	50
5.0SMDJ17A	5.0SMDJ17CA	5PEP	5BEP	17.0	18.90	20.90	1	27.6	181.16	20
5.0SMDJ18A	5.0SMDJ18CA	5PER	5BER	18.0	20.00	22.10	1	29.2	171.23	10
5.0SMDJ19A	5.0SMDJ19CA	5PET	5BET	19.0	21.10	23.30	1	30.8	162.44	10
5.0SMDJ20A	5.0SMDJ20CA	5PEV	5BEV	20.0	22.20	24.50	1	32.4	154.32	5
5.0SMDJ22A	5.0SMDJ22CA	5PEX	5BEX	22.0	24.40	26.90	1	35.5	140.85	5
5.0SMDJ24A	5.0SMDJ24CA	5PEZ	5BEZ	24.0	26.70	29.50	1	38.9	128.53	5
5.0SMDJ26A	5.0SMDJ26CA	5PFE	5BFE	26.0	28.90	31.90	1	42.1	118.76	5
5.0SMDJ28A	5.0SMDJ28CA	5PFG	5BFG	28.0	31.10	34.40	1	45.4	110.13	5
5.0SMDJ30A	5.0SMDJ30CA	5PFK	5BFK	30.0	33.30	36.80	1	48.4	103.31	5
5.0SMDJ33A	5.0SMDJ33CA	5PFM	5BFM	33.0	36.70	40.60	1	53.3	93.81	5
5.0SMDJ36A	5.0SMDJ36CA	5PFP	5BFP	36.0	40.00	44.20	1	58.1	86.06	5
5.0SMDJ40A	5.0SMDJ40CA	5PFR	5BFR	40.0	44.40	49.10	1	64.5	77.52	5
5.0SMDJ43A	5.0SMDJ43CA	5PFT	5BFT	43.0	47.80	52.80	1	69.4	72.05	5
5.0SMDJ45A	5.0SMDJ45CA	5PFV	5BFV	45.0	50.00	55.30	1	72.7	68.78	5
5.0SMDJ48A	5.0SMDJ48CA	5PFX	5BFX	48.0	53.30	58.90	1	77.4	64.60	5
5.0SMDJ51A	5.0SMDJ51CA	5PFZ	5BFZ	51.0	56.70	62.70	1	82.4	60.68	5
5.0SMDJ54A	5.0SMDJ54CA	5PGE	5BGE	54.0	60.00	66.30	1	87.1	57.41	5
5.0SMDJ58A	5.0SMDJ58CA	5PGG	5BGG	58.0	64.40	71.20	1	93.6	53.42	5
5.0SMDJ60A	5.0SMDJ60CA	5PGK	5BGK	60.0	66.70	73.70	1	96.8	51.65	5
5.0SMDJ64A	5.0SMDJ64CA	5PGM	5BGM	64.0	71.10	78.60	1	103.0	48.54	5
5.0SMDJ70A	5.0SMDJ70CA	5PGP	5BGP	70.0	77.80	86.00	1	113.0	44.25	5
5.0SMDJ75A	5.0SMDJ75CA	5PGR	5BGR	75.0	83.30	92.10	1	121.0	41.32	5
5.0SMDJ78A	5.0SMDJ78CA	5PGT	5BGT	78.0	86.70	95.80	1	126.0	39.68	5
5.0SMDJ80A	5.0SMDJ80CA	5PGB	5BGB	80.0	88.80	97.60	1	129.6	38.58	5
5.0SMDJ85A	5.0SMDJ85CA	5PGV	5BGV	85.0	94.40	104.00	1	137.0	36.50	5
5.0SMDJ90A	5.0SMDJ90CA	5PGX	5BGX	90.0	100.00	111.00	1	146.0	34.25	5
5.0SMDJ100A	5.0SMDJ100CA	5PGZ	5BGZ	100.0	111.00	123.00	1	162.0	30.86	5
5.0SMDJ110A	5.0SMDJ110CA	5PHE	5BHE	110.0	122.00	135.00	1	177.0	28.25	5
5.0SMDJ120A	5.0SMDJ120CA	5PHG	5BHG	120.0	133.00	147.00	1	193.0	25.91	5
5.0SMDJ130A	5.0SMDJ130CA	5PHK	5BHK	130.0	144.00	159.00	1	209.0	23.92	5



**Electrical Characteristics**

Type Number		Marking		Reverse Stand-Off Voltage	Breakdown Voltage		Test Current	Max. Clamping Voltage	Max. Peak Pulse Current	Reverse Leakage
				V <sub>R</sub>	V <sub>BR</sub> @I <sub>T</sub>		I <sub>T</sub>	V <sub>C</sub> @I <sub>PP</sub>	I <sub>PP</sub>	I <sub>R</sub> @V <sub>R</sub>
					Min	Max				
UNI	BI	UNI	BI	V	V	V	mA	V	A	μA
5.0SMDJ140A	5.0SMDJ140CA	5PHB	5BHB	140.00	155.00	171.00	1	226.8	22.05	5
5.0SMDJ150A	5.0SMDJ150CA	5PHM	5BHM	150.00	167.00	185.00	1	243.0	20.58	5
5.0SMDJ160A	5.0SMDJ160CA	5PHP	5BHP	160.00	178.00	197.00	1	259.0	19.31	5
5.0SMDJ170A	5.0SMDJ170CA	5PHR	5BHR	170.00	189.00	209.00	1	275.0	18.18	5
5.0SMDJ180A	5.0SMDJ180CA	5PHT	5BHT	180.00	200.00	220.00	1	291.6	17.15	5
5.0SMDJ190A	5.0SMDJ190CA	5PHV	5BHV	190.00	211.00	232.00	1	307.8	16.24	5
5.0SMDJ200A	5.0SMDJ200CA	5PHW	5BHW	200.00	224.00	247.00	1	324.0	15.43	5
5.0SMDJ220A	5.0SMDJ220CA	5PHX	5BHX	220.00	246.00	272.00	1	356.0	14.04	5
5.0SMDJ250A	5.0SMDJ250CA	5PHZ	5BHZ	250.00	279.00	309.00	1	405.0	12.35	5
5.0SMDJ300A	5.0SMDJ300CA	5PJE	5BJE	300.00	335.00	371.00	1	486.0	10.29	5
5.0SMDJ350A	5.0SMDJ350CA	5PJG	5BJG	350.00	391.00	432.00	1	567.0	8.82	5
5.0SMDJ400A	5.0SMDJ400CA	5PJK	5BJK	400.00	447.00	494.00	1	648.0	7.72	5
5.0SMDJ440A	5.0SMDJ440CA	5PJM	5BJM	440.00	492.00	543.00	1	713.0	7.01	5

**I-V Curve Characteristics**

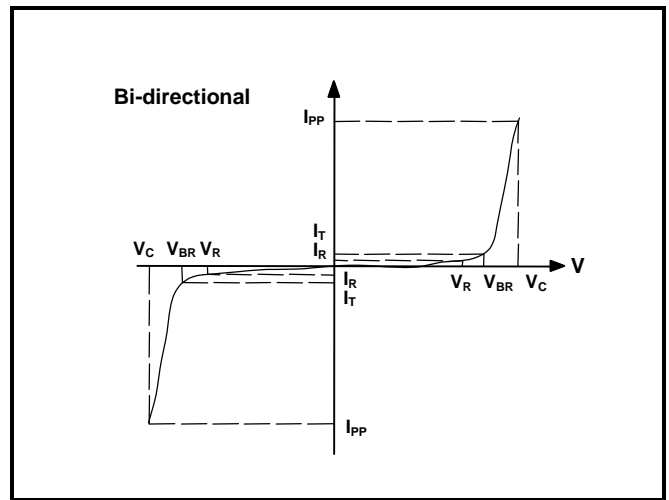
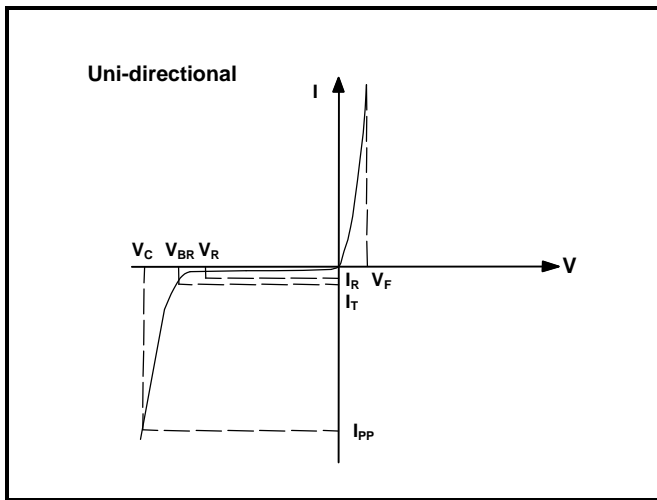

P<sub>PPM</sub> Peak Pulse Power Dissipation -- Max power dissipation

V<sub>R</sub> Stand-off Voltage -- Maximum voltage that can be applied to the TVS without operation

V<sub>BR</sub> Breakdown Voltage -- Maximum voltage that flows though the TVS at a specified test current (I<sub>T</sub>)

V<sub>C</sub> Clamping Voltage -- Peak voltage measured across the TVS at a specified I<sub>ppm</sub> (peak impulse current)

I<sub>R</sub> Reverse Leakage Current -- Current measured at V<sub>R</sub>

V<sub>F</sub> Forward Voltage Drop for Uni-directional



Ratings and Characteristic Curves ( $T_A=25^\circ\text{C}$  unless otherwise noted)

Figure 1 - TVS Transients Clamping Waveform

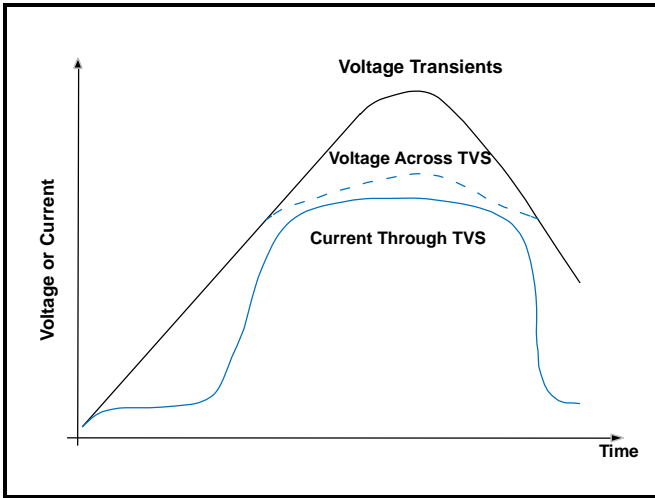

Figure 2 - Peak Pulse Power Rating Curve

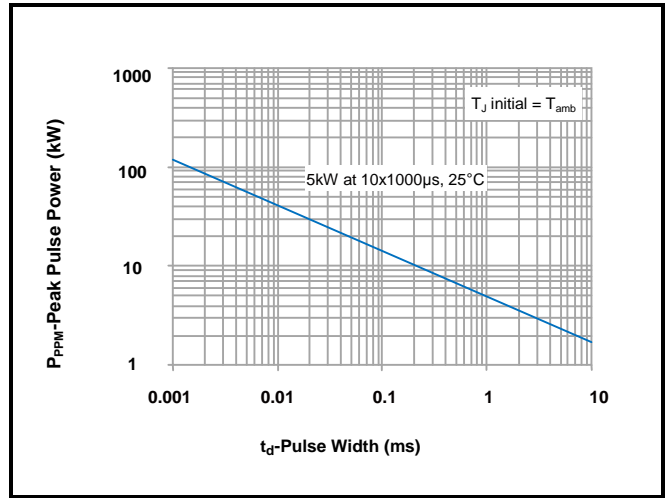

Figure 3 - Pulse Derating Curve

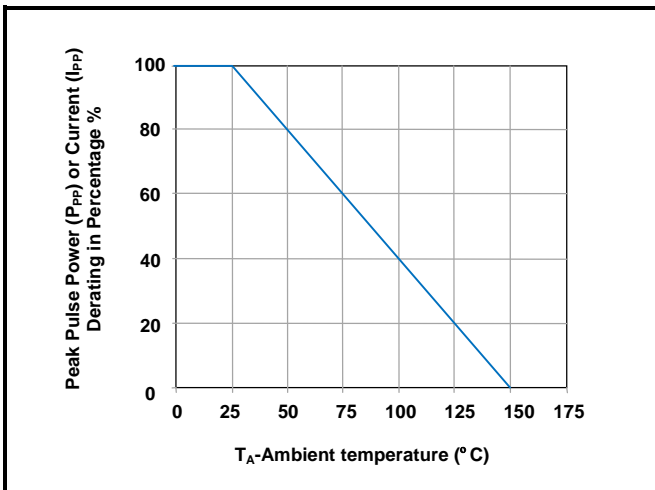

Figure 4 - Pulse Waveform

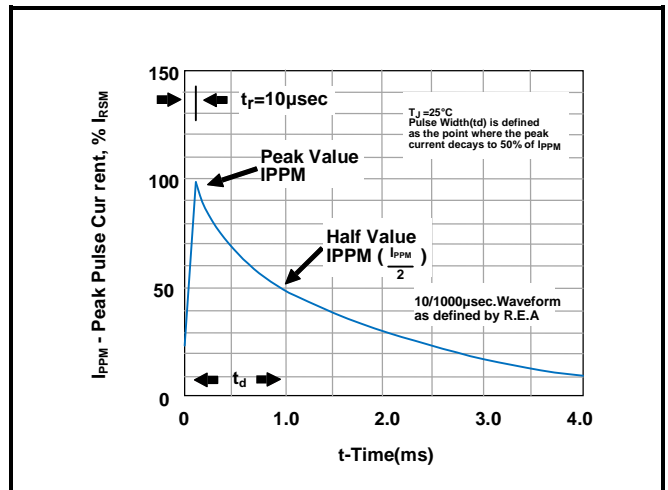

Figure 5 - Typical Junction Capacitance

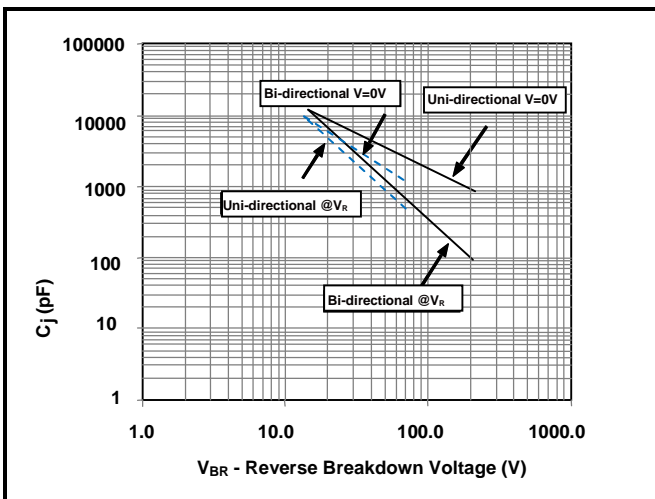

Figure 6 - Steady State Power Derating Curve

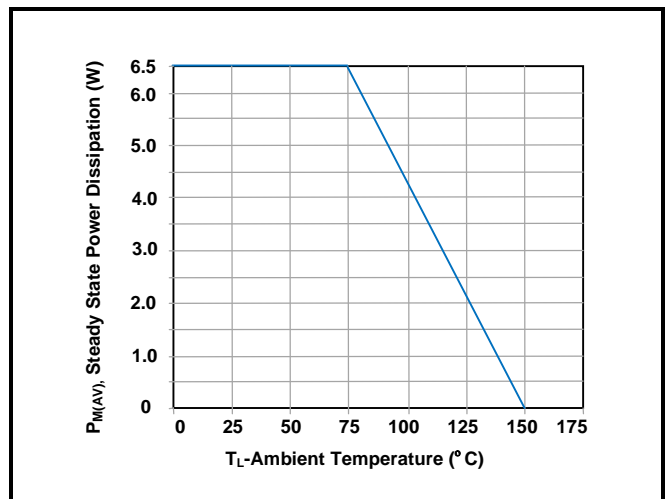
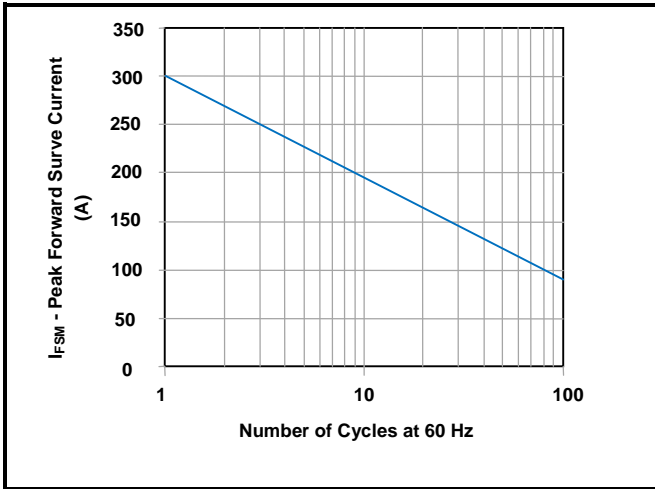
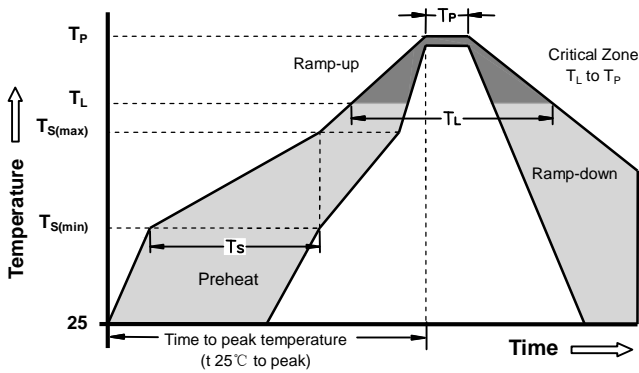

Figure 7 - Maximum Non-Repetitive Surge Current



Soldering Parameters - Reflow Soldering (Surface Mount Devices)



Reflow Condition		Pb - Free assembly
Pre Heat	-Temperature Min ( $T_{S(min)}$ )	150°C
	-Temperature Max ( $T_{S(max)}$ )	200°C
	- Time (min to max) ( $t_s$ )	60 -180 Seconds
Average ramp up rate ( Liquids Temp $T_L$ to peak)		3°C/second max
$T_{S(max)}$ to $T_L$ - Ramp-up Rate		3°C/second max
Reflow	- Temperature ( $T_L$ ) (Liquids)	217°C
	- Time (min to max) ( $t_s$ )	60 -150 Seconds
Peak Temperature ( $T_P$ )		260 +0/-5°C
Time within 5°C of actual peak Temperature ( $t_p$ )		20 - 40 Seconds
Ramp-down Rate		6°C/second max
Time 25°C to peak Temperature ( $T_P$ )		8 minutes Max
Do not exceed		260°C

Part Marking System

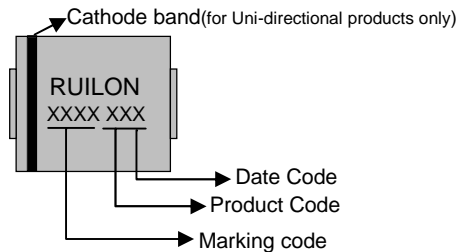

**Dimensions**

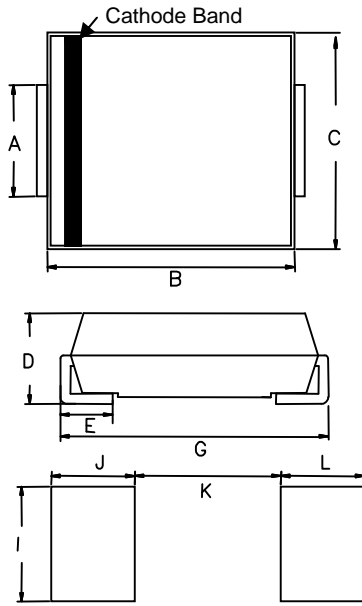

DIM	Millimeters		Inches	
	Min	Max	Min	Max
A	2.90	3.20	0.114	0.126
B	6.60	7.15	0.260	0.281
C	5.55	6.22	0.219	0.245
D	1.98	2.62	0.078	0.103
E	0.75	1.52	0.030	0.060
G	7.75	8.13	0.305	0.320
I	3.30	-	0.129	-
J	2.40	-	0.094	-
K	-	4.20	-	0.165
L	2.40	-	0.094	-

**Taping and Reel Specifications**

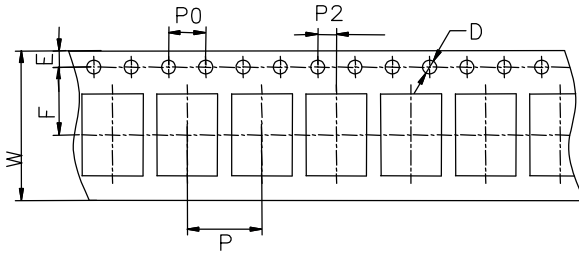

Symbol	Millimeters	Inches
W	16±0.3	0.630±0.012
P	8±0.1	0.315±0.004
F	7.25±0.1	0.285±0.004
E	1.75±0.1	0.069±0.004
D	1.5+0.1/-0.0	0.059+0.004/-0.0
P0	4±0.1	0.157±0.004
P2	2±0.1	0.079±0.004
D0	16.7±0.15	0.657±0.006
D1	178±2	7.007±0.079
D2	59.6+1/-2	2.346+0.039/-0.079
W1	17.2±0.4	0.677±0.016

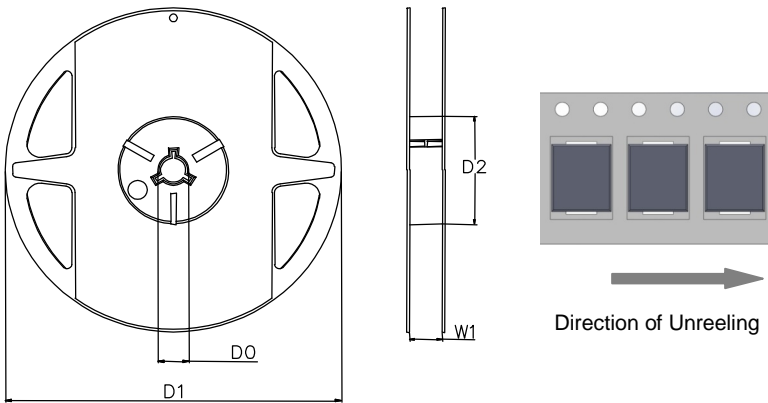

Part Number	Component package	Quantity	Packaging option	Packaging specification
5.0SMDJXXXXA/CA	DO-214AB	500	Tape&Reel-16mm/7"tape	EIA STD RS-481

